

GASPARDO



MTR RANGE

Double-disc precision vacuum planters

MTR RANGE

Double-disc precision vacuum planters

The MTR precision planters are among the best known and most highly valued GASPARDO products. A diversified range comprising various models catering to the demands of farmers the world over.

The MTR planting unit - which is a common feature across the whole range - is designed for quality planting, maintaining uniform depth and consistent seed spacing.

The GASPARDO precision planter range is the synthesis of a long journey, of accumulated know-how gained through whole generations, with a business record going back almost two centuries. From 1834 to date, GASPARDO has been unwavering in its mission: to provide farmers with increasingly accurate and innovative tools for their business.



JULIA

CONTENTS

MTR planting unit	4
Planting accuracy	6
Solutions catering to every demand	8
MINIMAX technology	10
PA1: front fertilizer hopper	12
Fixed-frame mounted planters	14
Twin-row mounted planter	16
Telescopic-frame mounted planters	18
Mounted planters with variable row spacing	20
Wing-fold mounted planters	24
MTR HD planting unit	28
Semi-mounted planters	30
Trailed planters for large areas	32
Closing the seed furrow and terminals	34
ISOTRONIC electric drive	36
Precision Farming	38



MTR planting unit

Planting in every imaginable condition

The MTR unit has been developed to ensure unbeatable efficiency and quality during precision planting. The strength of the frame, the variety of configurations and, above all, the double-disc furrow opener unit make this special planting unit perfect for any type of ground, whether conventionally or minimum tilled.



Sturdy parallel linkage

The cast steel linkage enables the implement to follow the ground's contours better, even when dealing with conditions that deviate from the linear.



Unit's variable pressure

The parallel linkage's down-pressure spring ensures that the implement sticks constantly to the ground's contours. Adjustable pressure up to 150 kg.



Maintenance free

The constant-velocity PTO drive shaft ensures consistent seed disc rotation without the need for maintenance.

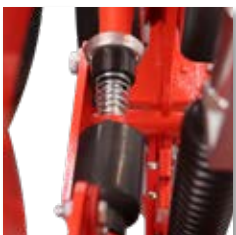

Planting row shut-off

Each planting unit drive can be conveniently disengaged either with the PTO shaft quick release or via the electric control feature.



Optimal seed-to-soil contact

The 4mm-thick 420mm Ø furrow opener discs create a very narrow V-shaped furrow, encouraging seed germination.



Planting on smooth ground

The front blade helps break up the soil, while the clod deflector moves any large material out of the planting path.

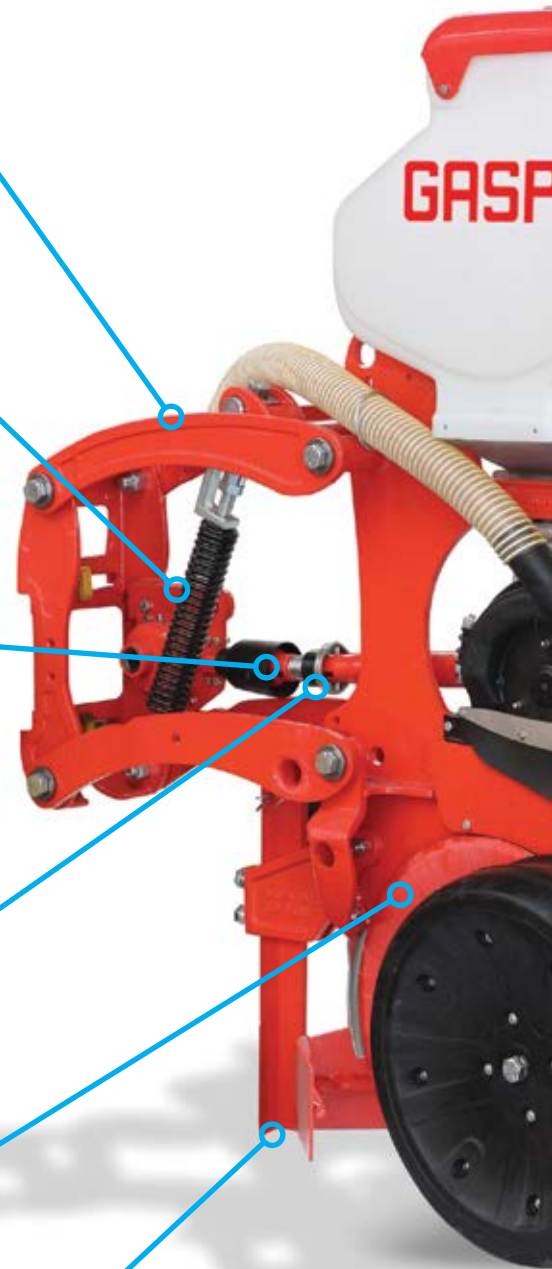

Long time between fills

The 36-litre hopper has been designed to minimize the space taken up by the machine for narrow rows, while the 60-litre version offers extended operating time between fills.



Handy disc inspection

The metering system is easy to inspect through the handy metal window, even while planting is in progress.



One seed at a time

The twin singulator system ensures the ultimate in seed spacing consistency, preventing doubles.

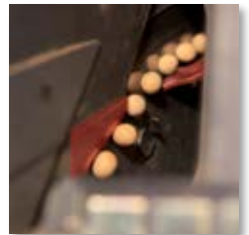

Fast seed discharge

The hoppers can be emptied by opening the hatch in the metering unit enclosure. The chute provided makes it easier to collect the seeds.



Long life

The metering unit's LONG LIFE CORE cover is made from plastic with hard-wearing gaskets. Replacing the seed metering disc is quick and easy.



Accurate depth control

The rear adjuster handle offers continuous accurate depth control (from 1 to 12 cm), even when dealing with small seeds.



Constant depth

The rocker-system depth gauge wheels are independent and ensure absolutely uniform planting depth.



Perfect closing action

The rear wheels close the furrow and can be spaced side by side or staggered. Pressure adjustment is lever operated with a choice of 7 settings.

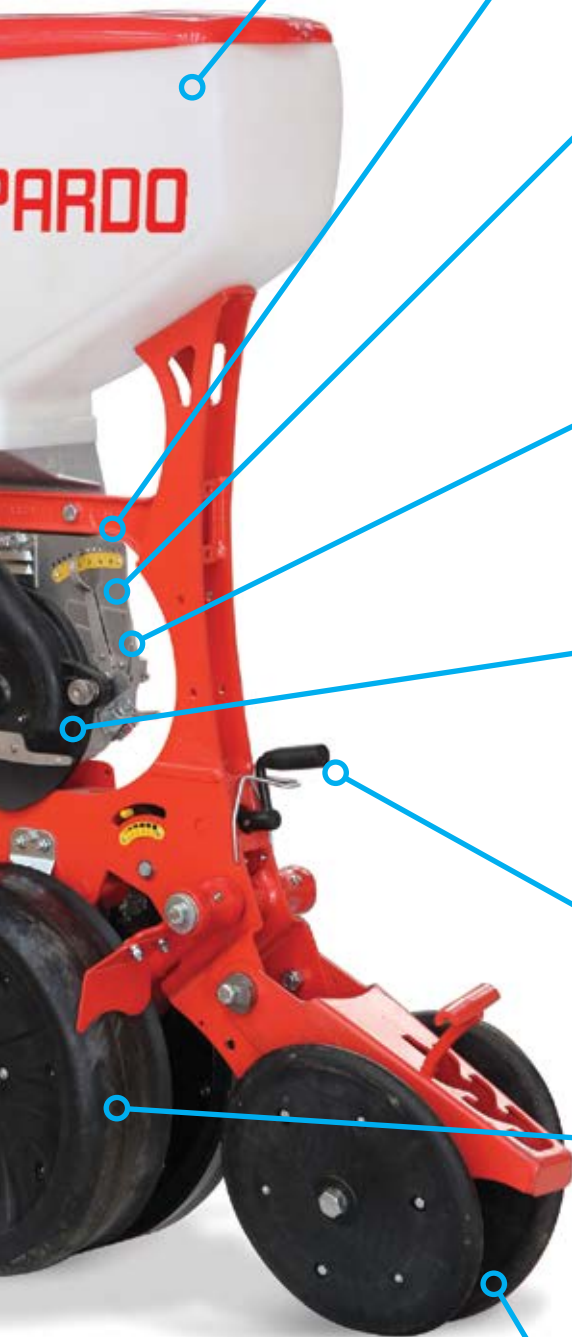

Planting accuracy

Seed spacing accurate to the millimetre!

Planting quality, which is a hallmark of the GASPARDO precision planter range, is the result of a seed metering system that is highly sophisticated, reliable and, at the same time, easy to adjust.



Quality metering!

Simple, effective and accurate metering goes hand in hand with quality planting. The metering unit body is the heart of the MTR planting unit: the strong, highly resilient material delivers the quality and accuracy that have always set GASPARDO products apart.

Choosing the right seed disc

The extensive range of GASPARDO perforated seed metering discs, together with the quality of the vacuum metering system, offers a series of solutions designed to ensure unbeatable uniformity even when dealing with seeds of different shapes and sizes.

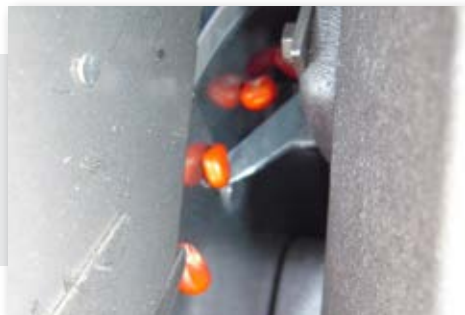

Adjustable twin singulator system

The twin singulator system ensures that just one seed is held in each hole in the disc. The first can be adjusted manually to suit the seed type, while the second is fixed. That way, seed singulation takes place both above and underneath the hole and can be checked through the inspection window.

Seed detachment guaranteed

The extractor ensures that seeds tending to cling to the seed disc detach properly. GASPARDO offers two extractor options, for both pelleted seeds (e.g. beet) and seeds protected with coatings (e.g. maize).

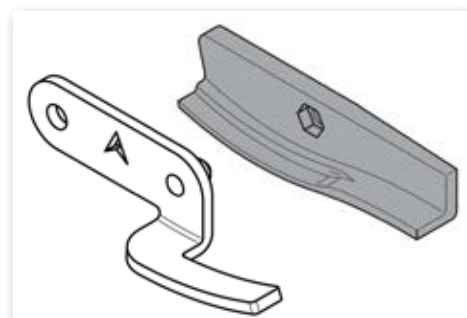

Smooth-flowing seed drop

The special shape of the delivery tube stops or limits seed bouncing during the drop. The tube clip keeps the tube perfectly centred, stopping it from touching the furrow opener discs. With no vibration to contend with, individual seeds drop more accurately and are placed gently in the furrow.

SEED
BRAKING
SYSTEM

(SBS)TM

Constant planting depth

Depth gauge wheels

The gauge wheels keep planting depth constant, even when working on uneven ground or soil with debris of various kinds, thanks to the rocker system that allows them to move independently.

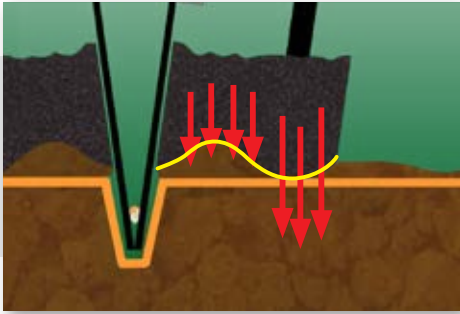

Soil firming

The wheels are specially shaped to firm the surface of the soil on either side of the seed furrow just created: their unique shape means greater pressure is applied at the outer edge, while the soil on the inside near the furrow is kept softer.

The largest furrow opener discs in the market!

The discs' 420 mm diameter means they form a very narrow V-shaped seed furrow that can be as deep as necessary. This improves seed-to-soil contact, ensuring optimal germination and fast plant emergence.

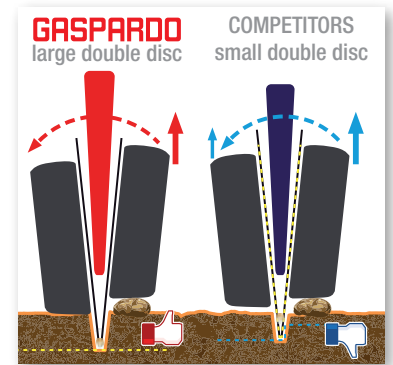

V-shaped furrow

The shoe placed between the two furrow opener discs gives the furrow a V-shaped cross-section, at the same time finely tilling the seedbed and providing loose soil to optimize seed germination.

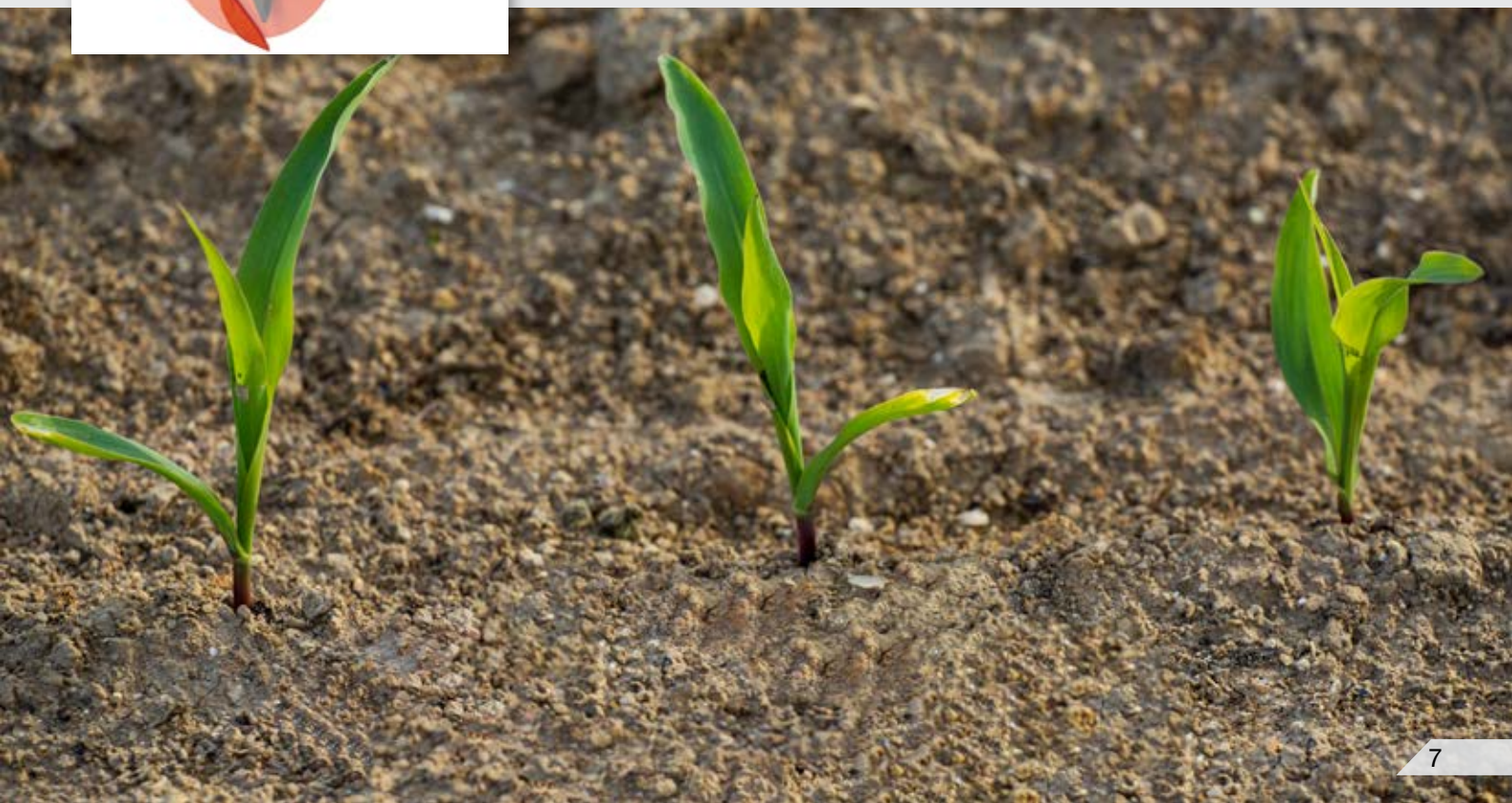

Solutions catering to every demand

Planters configured ad hoc to suit soil conditions

GASPARDO's selection of accessories offers a host of solutions to ensure your planting is perfect every time, no matter what the soil condition, catering to your individual agronomic and crop requirements.



Front blade and clod deflector

The vertical cutting action of the front blade makes it easier to slice through soil in tough or minimum tilled ground. The clod deflector pushes large clods or stones that might adversely affect germination quality, or overly dry soil, out of the planting path.

Disc couler

The front disc couler measuring 355 mm in diameter is suitable for initial slicing through tough or wet ground, where seed furrow opening is tough going. The rippled edge makes for more efficient crop residue cutting.



Trash wheels

Star wheels - for use on their own or in conjunction with the disc couler - move crop residue out of the planting path to ensure constant furrowing depth and effective furrow closure.

Spoked gauge wheels

The 3-spoke depth gauge wheels avoid the problem of mud plugging between them and the furrow opener disc when working in very wet conditions, especially on muddy-clayey soil.



60-litre hopper

The hopper version with a 60-litre capacity is available to maximize operating time between fills, for less downtime involved in reloading the hopper with seed.

Optimal seed firming

Seed firming wheel

The stainless steel wheel presses the seed directly into the V-shaped furrow to encourage its germination in light soil and soil with a medium consistency, and is particularly recommended for pelleted seeds (e.g. beet). By improving seed-to-soil contact, it allows for faster and more even crop emergence, even in tough soil conditions.



The right pressure

Stainless steel and 295 mm in diameter: the GASPARDO wheel is ideally designed for firming the seed into the soil. The soil scraper keeps the surface of the wheel in direct contact with the seed clean and free of wet soil.

Floating with disengage option

The wheel has a floating action, in other words it runs independently from the planting depth system: it rises and falls with the furrow and keeps uniform pressure on the seeds. The wheel can be easily lifted up when not needed.

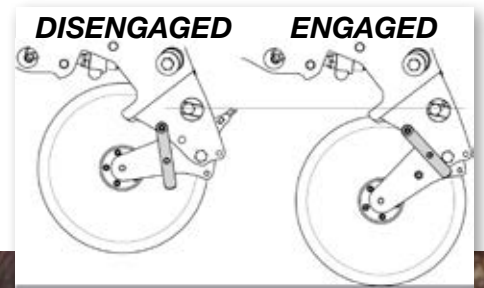

Seed covering paddles

The seed covering paddles, located straight behind the drop tube, draw loose soil into the seed furrow to ensure the best possible germination. A really valuable solution on wet and clayey soil to assist the inclined wheels in closing the seed furrow. The seed covering paddles can be adjusted to suit the required work intensity, and can be disengaged when not required in very dry soil conditions.

MINIMAX technology

Localized granular fertilizer placement

With the GASPARDO planters, the fertilizer spreader can be customized by choosing from different sized hoppers, made from plastic, stainless steel or painted sheet metal (including the PA front-lift option). By using the planter in conjunction with the appropriate furrowing system to suit soil types with surface crop residue, localized fertilizer placement to the side of the planting path is performed with adjustable spacing.

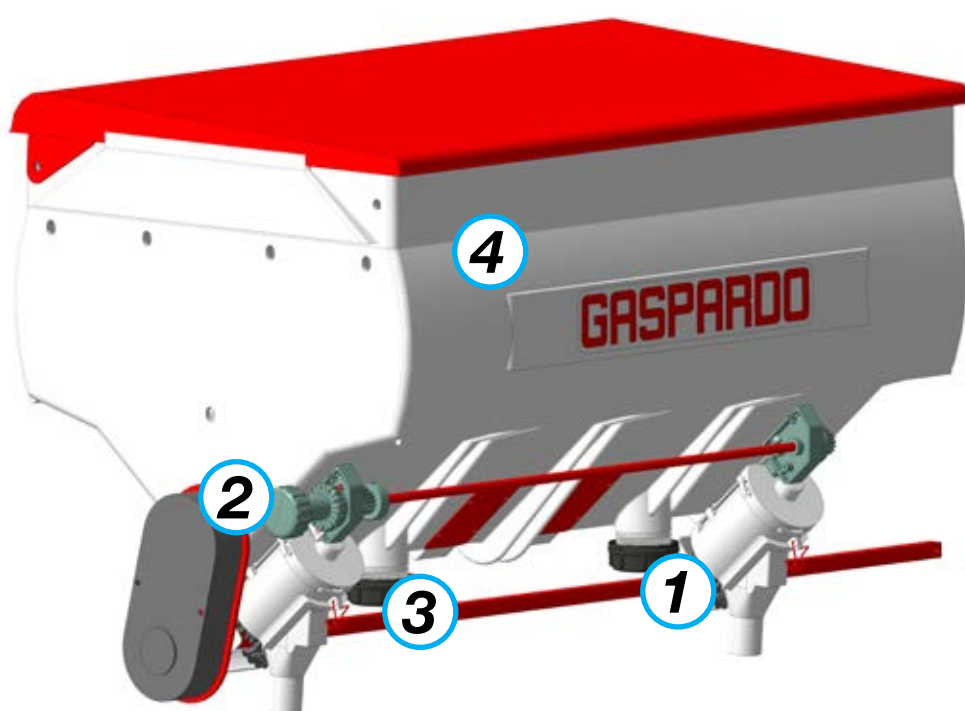

1

MINIMAX volumetric metering unit

Different metering rates can be set easily based on the type of product to be delivered.

3

Easy emptying

Outlets are provided for easy tank emptying for cleaning purposes.



Suffolk couler

Optimal solution for light-textured or fine, well-tilled soil, especially where there is little surface crop residue.



Double-disc couler

Suitable for both finely tilled and minimum tilled soils. The double disc cuts effectively through crop residue, creating the fertilizer trench.

Microgranule delivery

Crop protection and fertilizing during initial stages of development

GASPARDO's extremely practical MINIMAX microgranulator kit comprises a series of 16-litre tanks (30-litre optional extra) for granular products and a SPEEDY SET metering rate adjustment system. Soil-applied insecticides, as well as starter fertilizers, are delivered accurately into the seed furrow, even at very low rates.

2

SPEEDY SET

Central adjustment system for the MINIMAX meters: quick, accurate and effortless.

4

Clean and continuous flow

Inside, the removable mesh filters out foreign bodies, while the agitator on the bottom allows product to be conveyed to the metering units in a continuous flow.

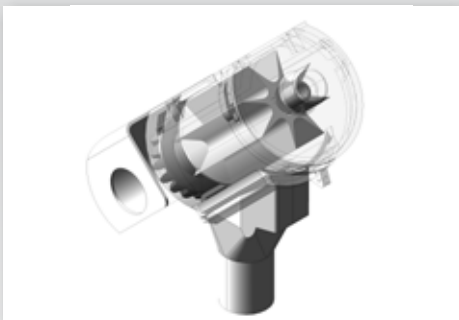
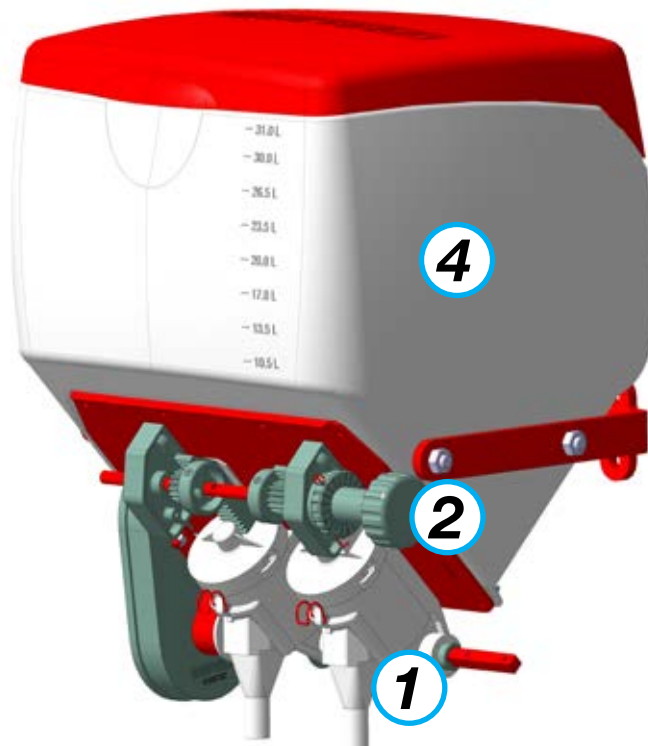

Volumetric metering unit

The MINIMAX volumetric metering unit meters the product accurately without damaging it thanks to the silicone rubber metering roller. The plastic material means no rusting and no need for lubrication.

The combination of two microgranulator kits allows two different products to be delivered at the same time. The product in the second tank can be routed into the main microgranulator tube or can be delivered separately, once the seed furrow has been closed (e.g. slug and snail killer).

Twin microgranulator



PA1 Front fertilizer hopper

Long time between fills

1,100-litre capacity hopper with handy opening for loading with big bags. Extension available to increase capacity by a further 400 litres.

Pneumatic conveying

Duct conveying fertilizer from the hopper to the coulters.

Uniform delivery

Easy-to-inspect steel volumetric metering unit with interchangeable roller.

Front work lights

Light assemblies with indicators for working in the dark or with poor visibility.

Blowing power

Smooth-flowing granule conveying, at both low and high rates.

Easy inspection

Steps for easier hopper filling and inspection.

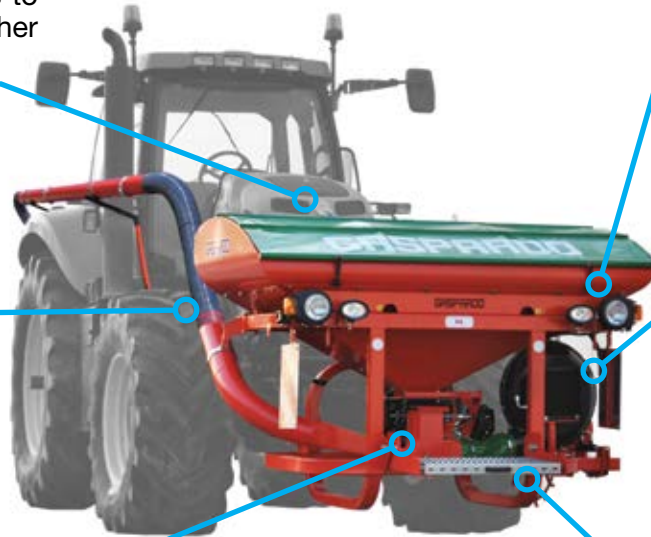

Optimal balancing

The PA1 hopper offsets a portion of the planter load with the tractor's front axle, decreasing soil compaction and improving manoeuvrability. The compact design offers full visibility from the driver's cab, both when working and during road travel.

PA1 PACKER with tired roller

PA1 PACKER sits on 4 tyres: this is the ideal solution for further decreasing soil compaction, achieving even better seed germination conditions.



Multipurpose design for different implements

With PA1, you are getting the most out of your investment as it can be paired with a number of different MASCHIO GASPARDO implements: as a hopper for fertilizer on HS row crop cultivators, or for seed on CENTAURO combi seed drills.



Electrically operated volumetric metering unit



Uniform metering

The volumetric metering unit meters the fertilizer automatically based on forward speed. With the GENIUS MASTER management system, variable rates can be applied depending on the product to be delivered. The aluminium casing and plastic used for the roller ensure long service life and corrosion resistance.

Twin-sector roller

The large diameter metering roller allows the speed of rotation to be reduced, ensuring reliable delivery. The two sectors with their offset cells are designed to avoid the "pulse" effect, for consistently uniform product feeding.



"GENIUS MASTER" ISOBUS system

The GENIUS MASTER system simplifies the job of setting fertilizer rates by allowing all operations to be performed from the driver's seat, and making it easy both to view work parameters and control the various functions. With the aid of satellite systems, fertilizer can be applied at variable rates based on information drawn from the prescription map loaded in the ISOBUS terminal (p. 38).

MAGA PA1



Solution available for MONICA, MAGICA, MAGA, MANTA and MANTA XL

Fixed-frame mounted planters



MTR

MTR
The MTR planter is the ideal solution for small farmers, perfect for farms where there are no width limitations for road travel. Available with both microgranulators and fertilizer spreaders, it delivers the best possible planting results every time.



Rear drive wheels

The planter's centre of gravity close to the tractor improves handling when turning in the field, making it easier for the tractor to lift the implement. The drive wheels are located to the rear.



Front drive wheels

To avoid the risk of getting stuck going over rocks and stones, the MTR also comes in a fixed-frame version with wheels positioned at the front.

Plastic or stainless steel fertilizer hoppers



Rugged mounted fixed frame

Model	Row spacing cm	Units n°	Fertilizer spreader n° x l	Frame length cm	Weight kg
MTR - 4R	75	4	1 x 850 / 2 x 160	250 / 280	800 - 1,010
MTR - 5R	75	5	2 x 200	350	920 - 1,170
MTR - 6R	45 / 75	6	2 x 160 / 2 x 280	250 / 440	940 - 1,300
MTR - 7R	60	7	2 x 280	420	1,130 - 1,410
MTR - 8R	75	8	4 x 160	580	1,360 - 1,930
MTR - 12R	45	12	4 x 200	580	2,020 - 2,650



MISTRAL

8.5m-long fixed-frame planter with 12 or 18 rows for high production demands. This solution combines value for money with performance, ideal for larger businesses requiring transport methods that are also suitable for long distances. It comes in both a light version and with a built-in trolley for easier transport.



Transport solutions

The light version is designed for road travel using the steering trolley, which is available as an optional extra. The version with built-in trolley features a frame with a folding drawbar for connecting directly to the tractor's hitch.



SERIO terminal

The SERIO terminal allows you to monitor parameters during work with its standard-issue 5.7" graphic display. Work data can be saved on the SD card.

375-litre hoppers

Fixed frame with folding drawbar

Double-disc fertilizer coulters



Model	Row spacing cm	Units n°	Fertilizer spreader n° x l	Frame length cm	Weight kg
MISTRAL - 12R	70	12	4 x 375	850	2,390 - 3,330
MISTRAL - 18R	45	18	4 x 375	850	3,030 - 4,030

Twin-row mounted planter

MTR TWIN

MTR TWIN

Precision planter model designed to plant twin rows in a single pass for improved seed placement: a feature that is especially useful with crops such as maize and soya. MTR TWIN is an innovative solution that ensures an increase in crop yield and consequent reduction in costs.



MTR NARROW planting unit

MTR NARROW is the independent combination of two MTR planting units specifically designed for high-quality twin-row planting, for a distance of 25 cm, with a row spacing of 75 cm.

Narrow depth wheels

The narrow (400 x 65 mm) planting depth gauge wheels allow soil and crop residues to flow smoothly between the twin-row units.



Chain drive

The MTR NARROW units on the back row are connected to the main mechanical drive by means of a chain drive.



Fertilizer spreader

MTR TWIN is fitted with multiple plastic hoppers with a 160-litre or 200-litre capacity for the fertilizer spreader, and with double-disc coulters.



Model	Row spacing cm	Units n°	Fertilizer spreader n° x l	Frame length cm
MTR TWIN - 4x2R	75	4 x 2	2 x 200	300
MTR TWIN - 6x2R	75	6 x 2	4 x 160	580
MTR TWIN - 8x2R	75	8 x 2	4 x 200	680



QUINCOINCE system

GASPARDO has developed QUINCOINCE, a metering system that is synchronized between the MTR NARROW twin-row units and designed to accurately stagger the seed discs, for placement in a triangular pattern, with the utmost reliability and accuracy.

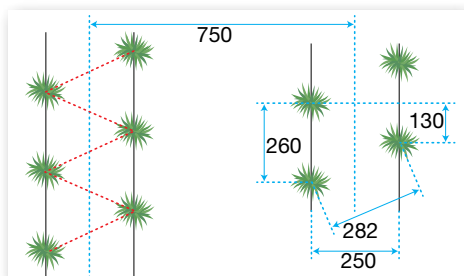

Improved seed placement

Set 25 cm apart, the twin-row units ensure a linear spacing of 26-28 cm between the staggered seeds. While it entails an increased planting population, crop coverage across the field is improved.

More efficient crop arrangement

The twin-row farming technique exploits the field more efficiently by ensuring:

- higher planting population
- better root and leaf development
- less competition for nutrients, water and light during growth
- natural weed control
- micro-irrigation with more efficient drip lines



A single investment

MTR TWIN allows crop management to be done with standard equipment, from row crop cultivators to harvesters. Row spacing stays the same, enabling tractors with classic track widths to be used for planting.



Telescopic-frame mounted planters



MTE

MTE
Practical and reliable, MTE is the ideal planter for small and medium farmers mainly concerned with planting maize, involving frequent road travel. The MTE model, with 6 or 7 planting units, has a 4.3m frame, with the outer units retracting telescopically to 3.0 or 3.4 m.



6-row model retracts to 3 metres for road travel

The dual telescoping frame gives a working width of over 4.0 m, but with a narrow transport width of just 3.0 m. Placing the wheels to the rear gives the utmost drive accuracy.



7-row model retracts to 3.40 metres for road travel

The 7-row MTE version with 60cm row spacing features a single-extension telescopic frame for a retracted width of 3.4 m, again with rear-mounted wheels.

400- or 1,200-litre hopper

Outer units telescope into closed position

Double-disc or suffolk fertilizer coulters

Rear drive wheels



Model	Row spacing cm	Units n°	Fertilizer spreader n° x l	Frame length cm	Weight kg
MTE - 6R	70 / 75	6	1 x 1,200	430	1,280 - 1,605
MTE - 6R	70 / 75	6	2 x 200	430	1,160 - 1,430
MTE - 7R	60	7	2 x 200	430	1,260 - 1,520



MARTA

MARTA is ideal for planting maize and other crops planted in widely spaced rows, minimizing width for road travel with its hydraulically retracted outer units. Optimal solution for areas with narrow lanes or roads with poor access.



Minimum transport width

With the drive wheels placed at the front, the double-extension telescopic frame means the implement can be retracted to 2.55 or 3.0 m, depending on the hopper chosen for the fertilizer.

Notched disc row marker

Front drive wheels



1,200-litre painted sheet metal hopper or 850-litre stainless steel version

Outer units telescope into closed position



Model	Row spacing cm	Units n°	Fertilizer spreader n° x l	Frame length cm	Weight kg
MARTA - 6R	70 / 75	6	1 x 850	400	1,150 - 1,400
MARTA - 6R	70 / 75	6	1 x 1,200	400	1,280 - 1,550
MARTA - 7R	50 / 60	7	-	400	1,390 - 1,480

Telescopic planter with variable row spacing



MONICA

MONICA

A benchmark for farmers and contractors for planting crops with different row spacing, MONICA is the mounted telescopic-frame planter that retracts to 2.55 m. Versatile model designed to allow you to work with a row spacing from 45 to 75 cm for planting different crops with a single investment. Double-disc or suffolk fertilizer coulters.



Adjustable telescopic frame

MONICA has an adjustable telescopic frame that, with its hydraulically operated telescoping action, gives a compact road transport configuration of just 2.55 m. With drive wheels positioned at the front, there is less risk of getting stuck going over rocks and stones.

Central unit disengagement

Using the optional central unit disengagement kit, the 7-row MONICA model can be converted to plant 6 rows with a 75cm row spacing.



850-litre stainless steel fertilizer hopper or front PA1

Outer units telescope into closed position

Double-disc or suffolk fertilizer coulters

Front drive wheels



Model	Row spacing cm	Units n°	Fertilizer spreader n° x l	Frame length cm	Weight kg
MONICA - 6R	45-75	6	1 x 850	413	1,260 - 1,680
MONICA - 7R	45-50 (60-75-80)	7 (6)	1 x 850	413	1,370 - 1,790

GASPARDO-designed variable row spacing



A single investment for all row crops

The variable row spacing on MONICA, MAGICA and MAGA ensures impressive versatility of use. These models can be used to plant all row crops - such as maize, soya, beet, rape, sunflowers, sorghum and cotton - with just a few straightforward settings, thus allowing you to change the row spacing in a matter of seconds.

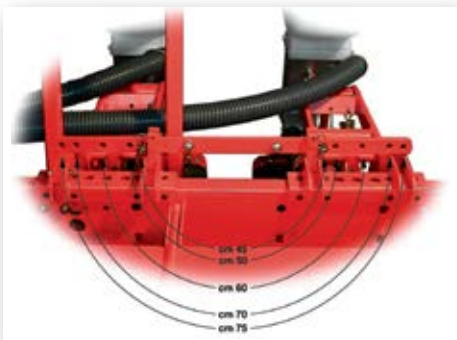

Fast row spacing adjustment

The end-of-travel bars allow the planter to be set with the desired row spacing. Simply move the locking pins on each planting unit to the relevant numbered holes. When you then switch on the hydraulic system, the units move to the chosen row spacing position.

Lever-operated transmission

The planters with variable row spacing feature a 16-speed transmission that can be set with two handy levers. That way, there is no need to adjust the sprockets and chains directly to set seed spacing.



Drive wheel spacers

The R22 front drive wheels on MONICA, MAGICA and MAGA can be spaced using the special kit for changing the planter's tread width.

Wing-fold planters with variable row spacing



MAGICA

MAGICA

The MAGICA model's operating versatility is the distinguishing trait of this wing-fold planter, which provides adjustable row spacing along with a suffolk coulters fertilizer placement system.

Suffolk fertilizer coulters

Removable folding wings

Front drive wheels



MAGA

MAGA is the wing-fold planter version featuring double-disc fertilizer coulters, which are ideal in high-trash situations, provided the ground is not stony.

Removable folding wings

Double-disc fertilizer coulters

Front drive wheels



Model	Row spacing cm	Units n°	Fertilizer spreader n° x l	Frame length cm	Weight kg
MAGICA/MAGA - 6R	45-50-60-70-75-80	6	1 x 900	457	1,330 - 2,000
MAGICA/MAGA - 7R	45-50-60 (70-75-80)	7 (6)	1 x 900	457	1,430 - 2,140
MAGICA/MAGA - 8R	45-50-60-70-75-80	8	1 x 900	600	1,710 - 1,910
MAGICA/MAGA - 9R	45-50-60 (70-75-80)	9 (8)	1 x 900	600	1,840 - 2,600
MAGICA - 12R	45-50 (70-75)	12 (8)	1 x 900	600	2,250 - 2,700



Adjustable wing-fold telescopic frame

MAGICA and MAGA feature a frame whose telescopic grouping of the planting units and folding wings translate into a transport width of just 3.0 m for the 6/7/8-row models and 3.2 m for 8/9/12-row models.

Removable side wings

The folding wings on the MAGICA and MAGA models can be easily removed to avoid obstacles around the edges of fields when working with a narrow row spacing.



MAGICA 12/8 rows

MAGICA also comes in the special electrically driven version that can be converted from 12 (45-50 cm) to 8 rows (70-75 cm). Using a simple kit that comes as standard, the units can be detached quickly and simply. Despite its overall 12 planting units, MAGICA 12 has a transport width of just 3.2 m.

Microgranulator with airflow

Transport width of 3.2 metres

12 to 8 row quick conversion kit

Narrow depth wheels

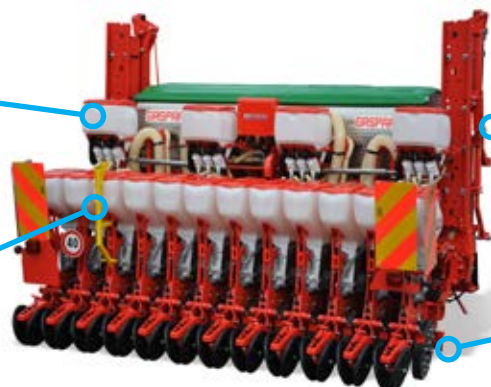

Wing-fold mounted planters



MIRKA

MIRKA

MIRKA is the ideal solution for professionals planning to perform planting and localized fertilizer placement using a single rear-mounted implement. The 8-row model with 75cm row spacing has a hydraulically operated wing-fold frame for a narrow transport width of just 3.0 m.



Rear drive wheels

The four drive wheels - two for the main frame and one for each folding wing - are positioned to the rear of the frame and have a generous section width.



Loading auger

The handy and practical auger makes filling the fertilizer spreader much quicker when big bags are not available.

1,400-litre fertilizer spreader



Hydraulically operated stack-folding side wings

Double-disc fertilizer coulters

Model	Row spacing cm	Units n°	Fertilizer spreader n° x l	Frame length cm	Weight kg
MIRKA - 8R	75	8	1 x 1,400	580	2,980 - 3,050

GASPARDO wing-fold frames

Frames built to adapt to the ground's contours

The wing-fold planters stand out for their impressive operational capacity and the ease with which machine dimensions can be adapted to suit the job thanks to hydraulic frames split into independently operated sections allowing them to be stacked.

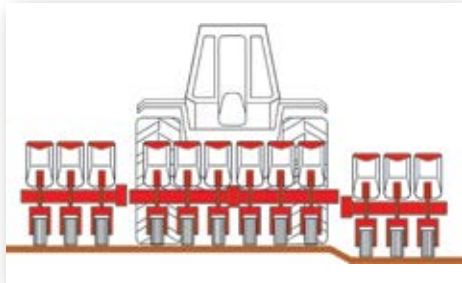

Independent-frame solutions

The side sections - which are floating during planting - allow the implement to better follow the contours of the ground and ensure it can get past obstacles without having to perform tricky manoeuvres. Each section has its own drive unit powering the planting units.

Wing compensation system
WINGS UP™ is the compensation system that keeps the side wings in the air while the planter is being lifted, improving manoeuvrability for easier steering even on sloping ground or for avoiding obstacles in the field.

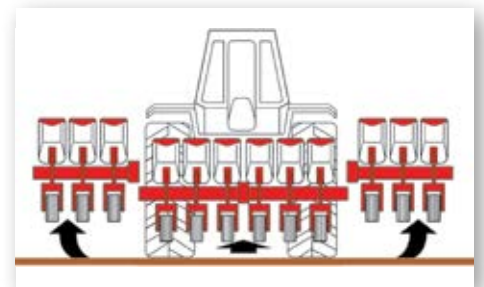

MANTA

Wing-fold mounted planters



MANTA XL

MANTA

Ideal for planting on any type of ground, MANTA teams seriously good operational capacities with practical use. Wing-fold model, perfect for use on ground that has not been uniformly tilled or on non-linear fields.



Folding wings

The hydraulic wing-fold frame allows the implement to be folded up quickly and safely for road travel with a transport width of 3.0 m.

Rear drive wheels for 8-row models; front wheels for 12-row models.



Compact frame

The 8-unit compact frame (TC) versions are designed to fold to 2.55 m for road travel, making them simpler to manoeuvre. The fertilizer spreader is available for use in conjunction with the PA1 front hopper and with suffolk coulters.

4 x 160-litre plastic hoppers available for long frame



Hydraulically operated stack-folding side wings

Model	Row spacing cm	Units n°	Fertilizer spreader n° x l	Frame length cm	Weight kg
MANTA TC - 8R	70 / 75 / 80	8	-	580	2,240 - 2,360
MANTA - 8R	70 / 75 / 80	8	4 x 160	580	2,260 - 2,820
MANTA - 12R	45 / 50 (75)	12 (8)	-	580	2,690 - 2,820



PA1 PACKER

MANTA XL

Built to cater to the demands of contractors and substantial farms, MANTA XL is the planter with a hydraulic folding frame featuring telescoping sections. Its high productivity, resulting from the 12 units with a 75cm row spacing, and ability to adapt to uneven ground contours make it an ideal instrument for planting professionals.



Frame with telescopic folding wings

The rugged frame with its folding wings is designed so that the outer wings can be folded up quickly and safely, at the same time retracting telescopically to give a width of just 3.0 m for road travel, despite its considerable working width. The drive wheels are located to the rear.

Model	Row spacing cm	Units n°	Fertilizer spreader n° x l	Frame length cm	Weight kg
MANTA XL - 12R	70	12	-	900	3,230 - 3,830
MANTA XL - 12R	75	12	-	900	3,230 - 3,830
MANTA XL 340 - 12R	80	12	-	960	3,230 - 3,830



MTR HD planting unit

Heavy-Duty planting unit for direct planting

When it comes to precision planting, MTR HD is the ultimate in efficiency and versatility. A unit meticulously developed to deliver top planting quality in untilled or very tough soil. MTR HD comprises a Heavy-Duty setup to meet requirements in particularly demanding working conditions, especially for planting in hard ground.



Long operating time between fills

On the MTR HD unit, the seed hopper has a 60-litre capacity to optimize the planters' productivity and reduce downtime while the operator refills the hopper.



Quick crop emergence

The furrow closing assembly on the MTR HD model is cast from steel and delivers high down pressure to close the furrow. The standard 1"x14" inclined wheels are made from rubber, though there is a cast iron option available for tougher ground.

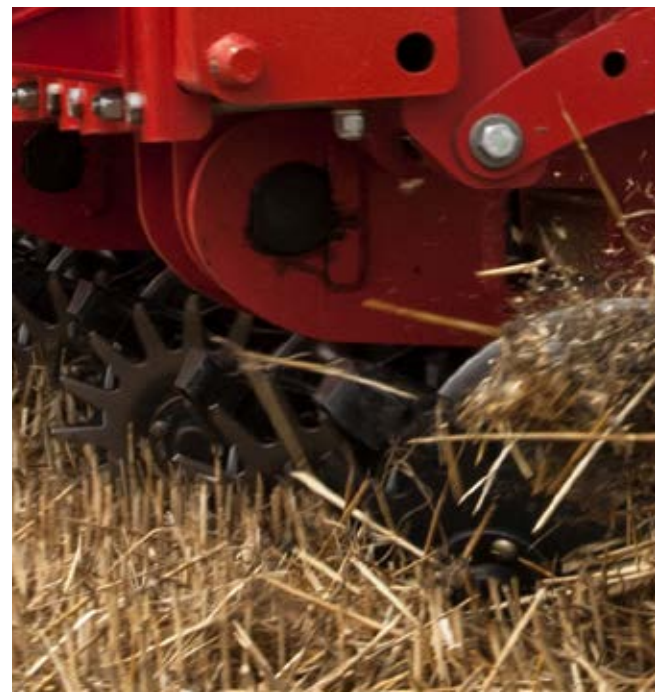

Planting has never been so direct!

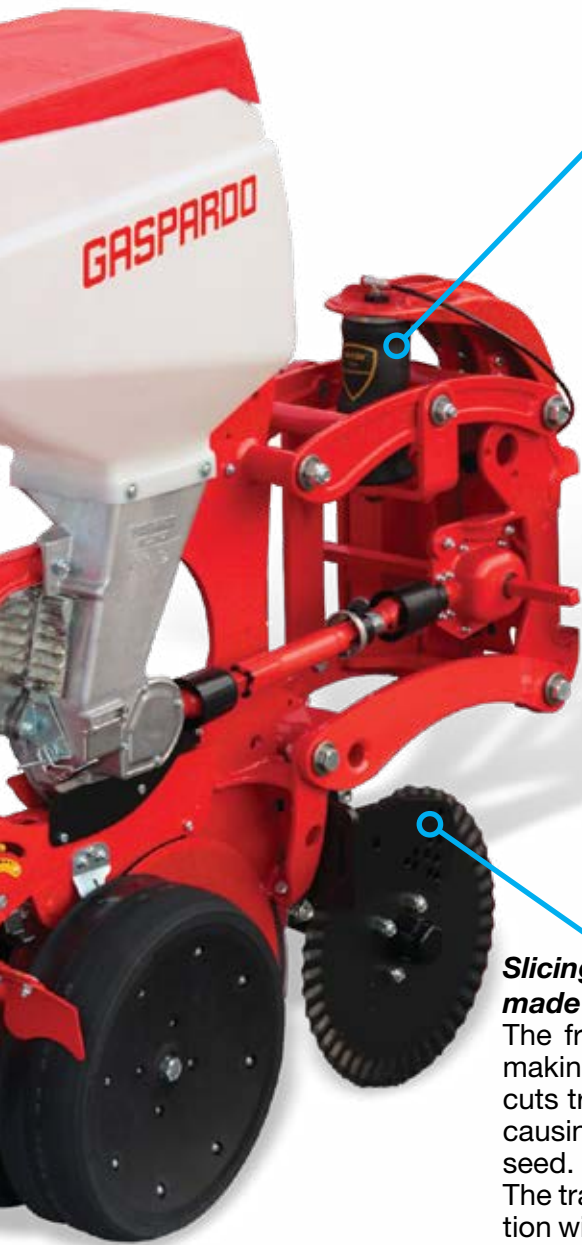

Unbeatable down pressure!

With AIRSPRING, down pressure is produced by centrally controlled air bearings. The MTR HD unit's extensive pressure range ensures versatility of use on everything from tilled soil to the most stubborn hard ground.

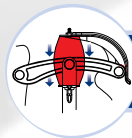

AIRSPRING

Slicing and clearing of the planting path made easy

The front disc coultter slices through the soil, making opening furrows easier, while it also cuts trash to stop it folding into the furrow and causing germination issues on contact with the seed.

The trash wheel, which can be used in conjunction with the coultter, is useful when dealing with a considerable amount of surface crop residue. It shoves biomass out of the planting path into the gap between the rows, keeping the seed placement depth constant.



Semi-mounted planters



RENATA HD

ROMINA: fixed frame

A versatile, high-performance planter, ROMINA can be paired with lighter tractors at the lower end of the power range thanks to its trailed fixed frame. The two-point hitch and hydraulic lifting wheels make manoeuvring even easier. The drawbar can be folded so that less space is needed to store the machine.



Handy fertilizer rate adjustment

The three-cam oil bath gearbox centralizes fertilizer rate control on the side of the hopper. The lever with its graduated scale simplifies the procedure considerably.



Distribution auger

The distribution auger system delivers any form of fertilizer extremely accurately, whether granular with varying particle sizes or powdered products.

Double-disc fertilizer coulters



Plastic hoppers (2 x 800 litres)

Folding drawbar

Model	Row spacing cm	Units n°	Fertilizer spreader n° x l	Frame length cm	Weight kg
ROMINA - 6R	70 / 75 / 80	6	2 x 800	520 - 580	2,100 - 2,630
ROMINA - 8R	70 / 75 / 80	8	2 x 800	580 - 750	2,200 - 2,900



RENATA R and RENATA HD: folding frame

A perfect solution in every imaginable condition, RENATA HD is the optimal choice for businesses regularly transitioning between planting in conventionally or minimum tilled soil and in hard ground. A rugged frame and MTR HD planting units make RENATA HD the ideal companion for the most demanding contractors.

Another option is RENATA R, featuring the classic MTR planting unit, for conventionally or minimum tilled soils.



Front folding

The semi-mounted frame on the RENATA models folds forwards, reducing the width for road travel to just 3 metres. The folding operation takes just a few seconds, making the implement easy to move from one field to the next.

Tyre contact drive

The tyre contact drive system ensures uniform transmission in any operating conditions, immediately disengaging seed distribution when the planter is raised during turns in the field.



Notched disc row marker

1,600-litre plastic hopper

Double-disc fertilizer coulters



Model	Row spacing cm	Units n°	Fertilizer spreader n° x l	Frame length cm	Weight kg
RENATA R - 8R	70 / 75	8	1 x 1,600	600	3,700 - 4,450
RENATA HD - 8R	70 / 75	8	1 x 1,600	600	3,700 - 4,450

Trailed planters for large areas

JULIA

METRO

The folding trailed frame, with 2 floating sections, even adapts well to ground that is not perfectly flat. The front folding design reduces the transport width to 6.0 m.

The main frame can be combined with the 12m-wide MEGA in-line planter

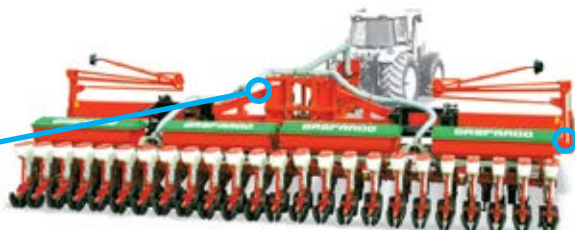

Painted sheet metal hopper
(4 x 950 litres)

Model	Row spacing cm	Units n°	Fertilizer spreader n° x l	Weight kg
METRO - 16R	70	16	4 x 950	2,240 - 2,360
METRO - 18R	70	18	4 x 950	2,260 - 2,820
METRO - 24R	45	24	4 x 950	2,690 - 2,820

MAXIMETRO

The highly flexible folding trailed frame split into 3 sections follows the contours of the ground with an overall range of 16 degrees, keeping planting depth constant across all units. The quick folding design means the machine can fold up to a transport width of 6.0 m.

7,500-litre centralized fertilizer hopper

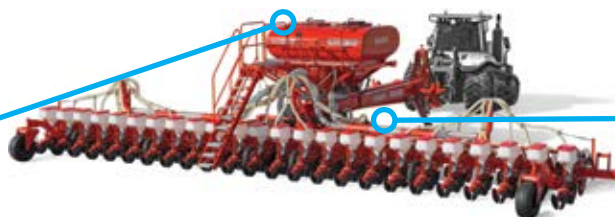

Road travel on rubber tracks

Model	Row spacing cm	Units n°	Fertilizer spreader n° x l	Weight kg
MAXIMETRO - 24R	70 / 75	24	1 x 7,500	2,240 - 2,360
MAXIMETRO - 36R	70	36	1 x 7,500	2,260 - 2,820



JULIA

JULIA is GASPARDO's new flagship model, featuring an impressive operational capacity thanks to its 24 planting units - for a remarkable 16 metre field working width - and the flexible frame, with an overall range of 10 degrees. The front folding design of the two frame sections produces a narrow transport width for road travel. The high-capacity hopper is divided into two compartments: 2,000 litres for the seed and 7,000 litres for the fertilizer. The three watertight, wide-opening hatches make filling with big bags that much easier. The MTR HD planting unit delivers high standards of planting no matter what the field conditions.

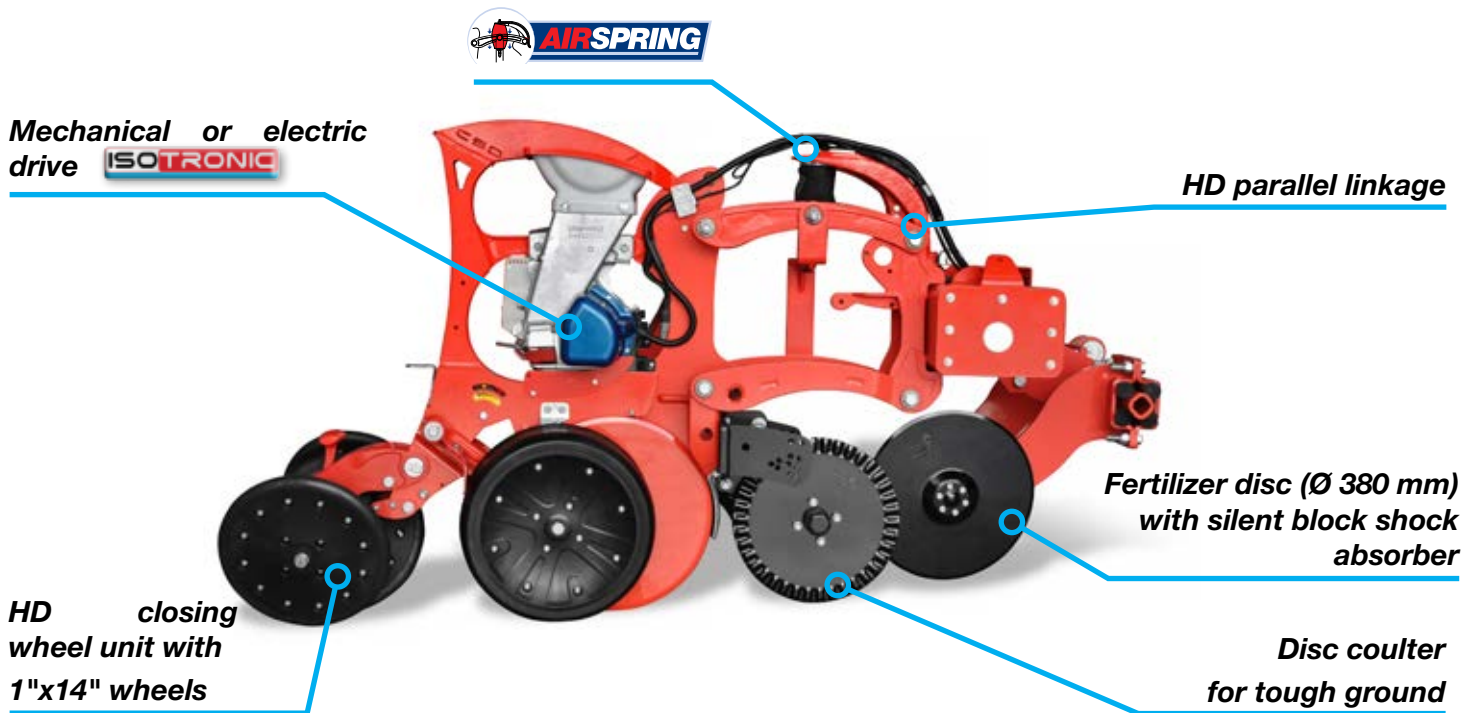

Model	Row spacing cm	Units n°	Seed capacity n° x l	Fertilizer capacity l	Frame length cm
JULIA 24R	70	24	2,000	7,000	1,680

Closing the seed furrow

The closing wheel unit

Inclined to form a V, the wheels finish off the planting operation by closing the furrow, drawing fresh soil over the trench and pressing down on it. The resulting firming action means excellent seed-to-soil contact, optimizing germination and crop emergence.

Mount for MTR: pressed steel with 7-setting adjustment lever and 3 wheel options



Rubber wheels 12" Ø 2" section width

For loose, well tilled, not overly wet soils.



Rubber wheels 12" Ø 1" section width

For tough, very wet or minimum tilled soils.



Cast iron wheels 12" Ø 1" section width

For minimum tilled or very tough soils.

Mount for MTR HD: cast from steel with 5-setting adjustment lever and 2 wheel options.



Rubber wheels 14" Ø - 1" section width

For minimum tilled soils.



Cast iron wheels 14" Ø - 1" section width

For tough soil, especially with hard ground conditions.

Adapting to any planting condition: it is essential to adjust the furrow closing assembly with a few simple settings to suit the soil type, agronomic requirements and operating conditions in the field.



Wheel spacing

Optimizes furrow closure based on planting depth and avoids trash or stones clogging or becoming tangled up in the unit.



Wheel stagger

Encourages residue and soil to flow smoothly between the wheels, minimizing the risk of foreign matter getting caught up

Planting terminals

Keep a check on all parameters with the right terminal

A specialist in the precision planting field, GASPARDO offers a series of terminals - complete with display and ready for mounting in the tractor cab - for managing work parameters and controlling electric row shut-off.

HCS



- Area worked, partial and total (ha)

V1200



up to 12 rows

- Planting per row monitoring alarm
- Area worked, partial and total (ha)

MCE 6000



up to 6 rows

- Planting per row monitoring alarm
- Area worked, partial and total (ha)
- Operating speed (km/h)
- Average seed spacing per row or total (cm)
- Planting density (seeds/m²)
- Ready for connection of row shut-off

MCE 12000



up to 12 rows



Electromagnetic unit shut-off

The electromagnetic shut-off devices allow planting units to be shut off individually via the electric command given by the MCE terminal or using the ISOBUS protocol. Power is shut off to the planter, without any risk of damage to the seeds. Following a break in planting, operation is resumed instantly, given that the vacuum system stays on.

Seed monitoring photocells

The photocells on the metering unit body outlet check that the seed actually enters the delivery tube. The audible seed monitoring alarm promptly warns the operator if no seed is detected or the hopper is empty.



Electric drive

Electrically driven planters

ISOTRONIC is the revolutionary electric drive system based on the ISOBUS communication protocol for MTR and MTR HD planting units. An innovative solution that simplifies the planters' mechanical construction: in lieu of gearboxes, chains and PTO shafts, the tractor's terminal becomes the planting control centre.



Technology that meets farmers' needs

- Less mechanical parts requiring maintenance
- Seed spacing managed via the tractor terminal
- Planting functions monitored and changed in real time
- ISOBUS communication between planter and tractor
- Management via GENIUS MASTER
- Precision Farming: variable rate and automatic section shut-off
- Remote link with MG-Live (Agriculture 4.0)



Seed spacing with unbeatable consistency

Each unit has an electric motor that drives the seed disc directly: metering is accurate and immediate, a quality that makes **ISOTRONIC** the ideal solution for perfect seed spacing, even at high work rates.

Planting quality and resource optimization

ISOTRONIC takes planting quality to the next level, eliminating the inaccuracy that is inevitably with the construction limitations of mechanical systems. With the electric drive, the use of farming inputs is optimized, with a resulting reduction in waste and greater production efficiency.



Seed disc

Seed discs are compatible and interchangeable with their counterparts on conventional GASPARDO planters

Hexagonal shaft head

Unbeatably consistent metering disc rotation

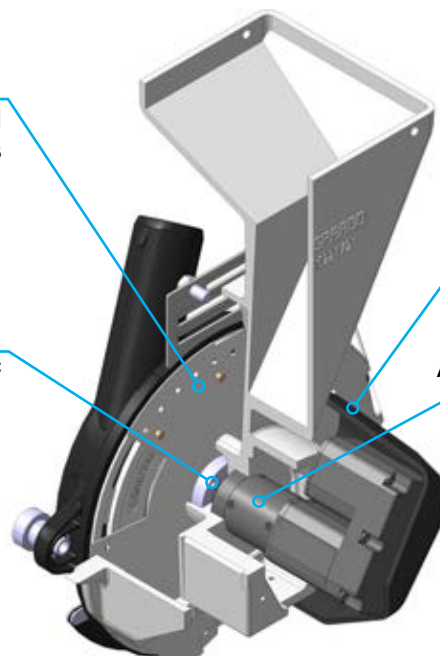

Guard

Protects the electric motor **from knocks and dust**

12V electric motor

Airtight housing, unbeatable reliability and longevity

GENIUS MASTER



ISOBUS universal language

GENIUS MASTER makes communicating with **ISOTRONIC** extremely simple through the tractor's ISOBUS terminal: a single connecting cable is used to link the planter/tractor for monitoring and controlling all planting functions.



Universal connecting cable



Compatibility with MASCHIO
GASPARDO ISOBUS equipment



Universal language
shared with leading tractor brands

Solutions for non-ISOBUS tractors

GASPARDO supplies a compatibility kit, which comprises the ISOBUS terminal and cabling to enable communication between **ISOTRONIC** and non-ISOBUS tractors.



TERA 7

- Seed spacing control
- Planting alarms
- Manual section shut-off
- Planting parameter display



TOUCH 800

- TERA 7 functions
- Prescription map import
- Georeferenced planting data export
- Automatic section shut-off
- Variable input rate

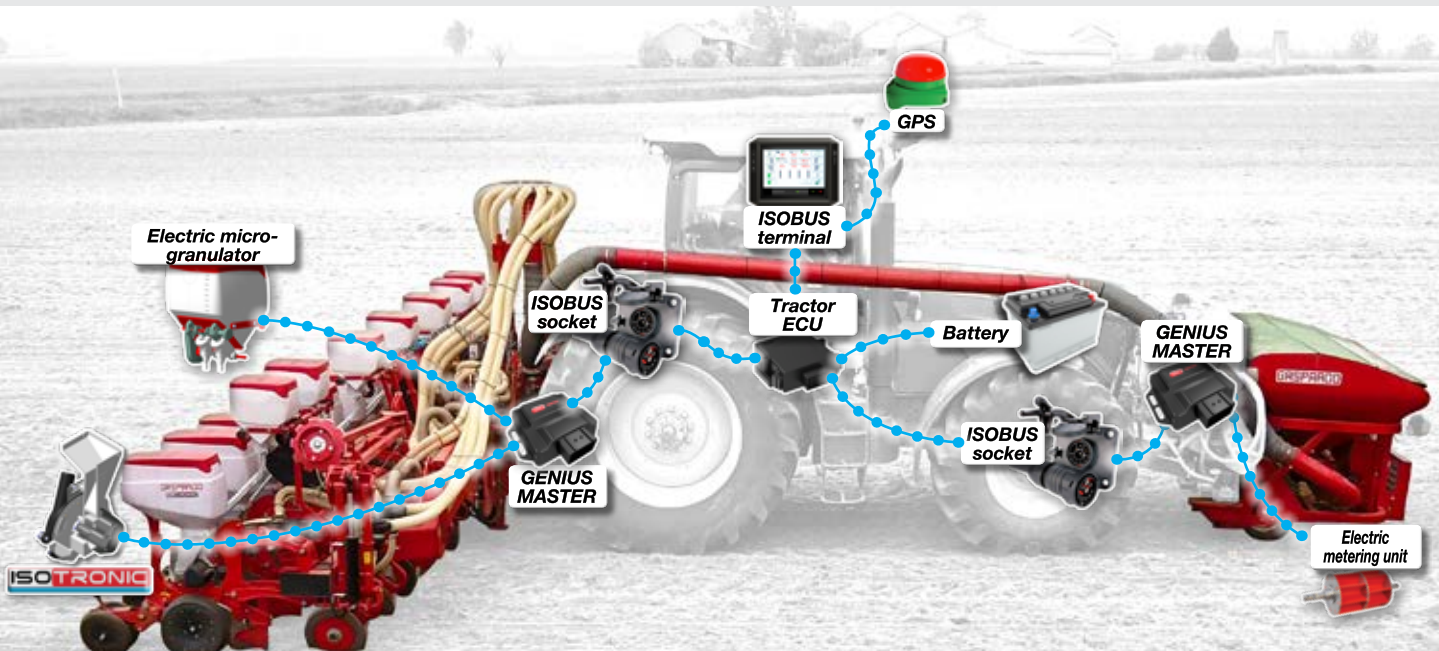

Precision Farming



ISOTRONIC, technology at the cutting edge of Precision Farming

The GENIUS MASTER system fully harnesses Precision Farming-related ISOBUS functionality. In this sense, the terminal takes prescription maps and translates the information they give on the conformation and variable fertility of soils, relaying relevant automatic commands to **ISOTRONIC**.



Universal Terminal

Functionality enabling each ISOBUS terminal to communicate with the GENIUS MASTER system to manage **ISOTRONIC**. A single monitor in the tractor cab is all that is needed to control the planter and the front hopper (if any) paired with it.



Export work data

It allows you to import and read prescription maps as well as export to a PC the log of georeferenced planting data calculated with **ISOTRONIC**.



Variable seed rate

It programs variable seed density based on the different production potential of farmlands that often vary widely, making for more efficient use of your farming resources.



Automatic section control

Planting sections are switched on and off automatically thanks to mapping of the field boundaries and recording of areas that have already been worked. There is no overlap of areas that have already been planted, meaning considerable cost savings and more efficient management.



Agriculture 4.0 with MG-Live

A strategic vision of your planter!

While Precision Farming provides the tools for optimizing crop yields based on the soil's spatial variability, Agriculture 4.0 is the ultimate epitome of innovation and technology. MG-Live is a system that exploits the mobile network to interconnect GASPARDO planters: with it, farmers can modernize and switch to Agriculture 4.0 to espouse a strategic vision of all their GASPARDO planters and the relevant tasks they perform, ensuring that they are working to their full potential.



MG-Live, just plug and play!

The MG-Live device provides a remote connection between the planter and web portal enabling farmers to monitor planting in real time, while also allowing the MASCHIO GASPARDO technical support department to provide technical assistance.



Planters under constant control

With MG-Live, you can access your planters at any time from a PC or via the app to monitor both geolocation and planting data in real time.



Remote Service

MASCHIO GASPARDO service

The planter's GENIUS MASTER system receives updates directly from the MASCHIO GASPARDO technical support department.



GASPARDO

MASCHIO GASPARDO S.p.A.

Headquarters and production plant
Via Marcello, 73
I-35011 Campodarsego (PADOVA) - Italy
Tel. +39 049 9289810 - Fax +39 049 9289900
info@maschio.com - www.maschio.com

Production plant

Via Mussons, 7
I-33075 Morsano al Tagliamento (PN) - Italy
Tel. +39 0434 695410 - Fax +39 0434 695425