

Rapid

Impressive results in all conditions





Where farming starts

Together with farmers all over the world, we have spent the last three generations creating machines that make any farmland find its full potential. The high quality Väderstad planters, seed drills and tillage equipment give farmers a head start by covering more ground in shorter time without losing perfection.

Together we make you an even more successful farmer.



The universal seed drill

Rapid is a universal seed drill that carries out seedbed preparation, levelling, drilling and reconsolidation in one pass. Its design offers a reliable seeding result at high working speed. Its capacity offers possibility to optimise timing. Direct drilling, reduced tillage or conventional tillage – Rapid creates perfect seeding results in all conditions.



Save time, diesel and soil moisture

By performing multiple operations in one pass, the Rapid seed drills reduces the operations on the field. This saves time, lowers input costs, and preserves soil moisture.

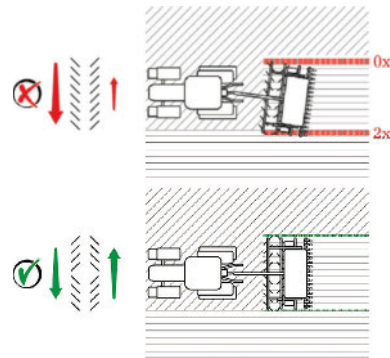
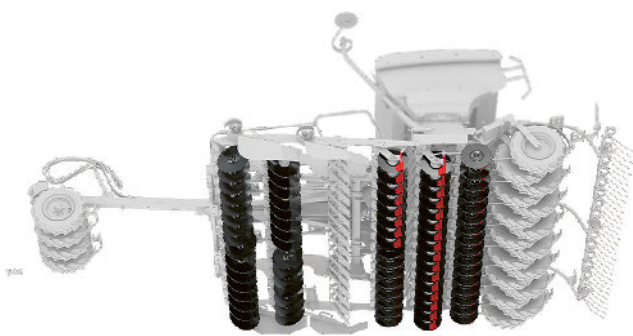
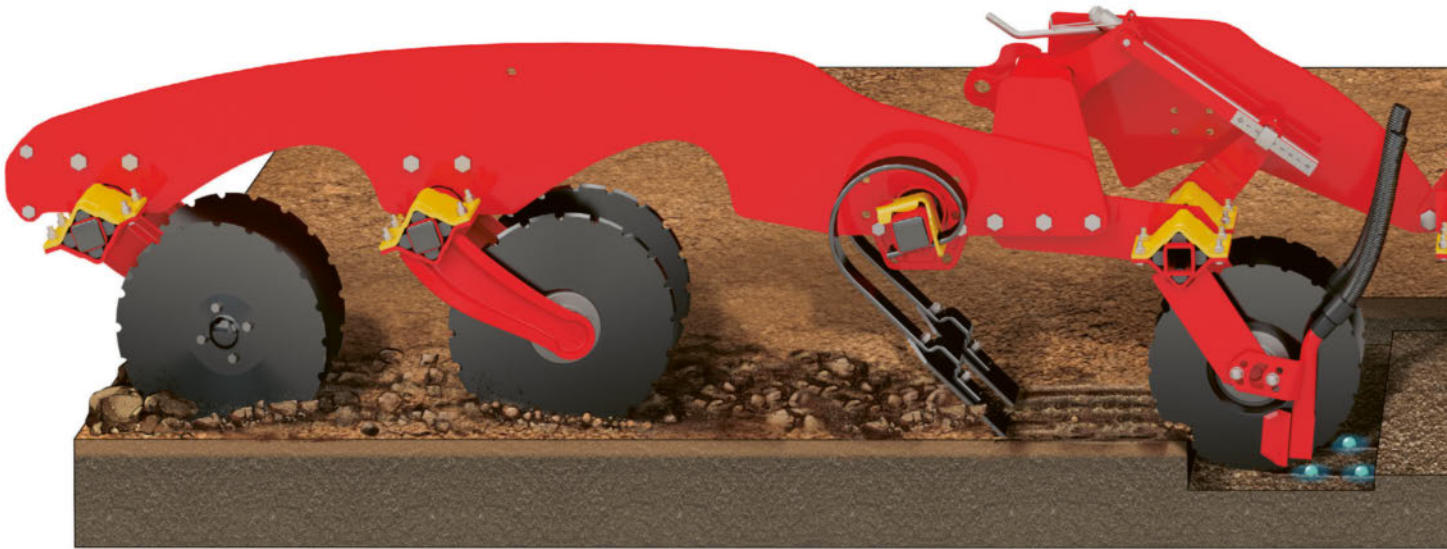

Aggressive seed discs adds intensity

One of the unique features of the Rapid disc seed couler is its cultivating ability, adding further intensity to the soil preparation of the front tools.

More soil preparation during drilling means less passes needed for preparation. Less passes ahead saves ground moisture and retains soil structure, maximising the plant potential.

X-disc – Straight run for maximum output

To gain full control, it is very important that the seed drill does not alter from its straight track behind the tractor. Something that is further essential in hilly conditions.

Because of the x-disc setup of the front tool, Rapid will always travel in a straight line behind the tractor. The Väderstad x-disc is crucial to reach the full potential of a GPS- or RTK-system on the tractor.

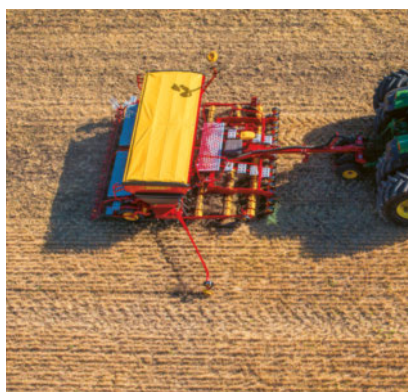

Direct drilling

Thanks to Rapid's powerful front tools and high coulters pressure, it is able to drill directly into stubble when needed.

Direct drilling drastically reduces costs and saves ground moisture.

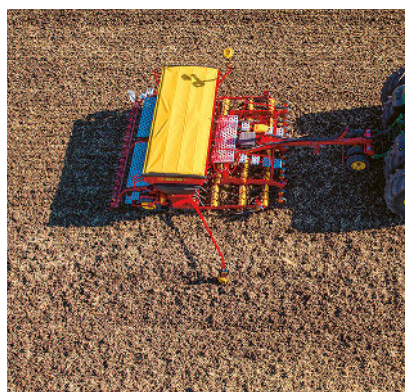

Minimum tillage

The large diameter single disc coulters, enable Rapid to handle high amounts of crop residues, without compromising seeding results.

Rapid is the ideal choice for minimum tillage.



Conventional tillage

By performing several operations in one pass, Rapid preserves moisture and levels the field effectively.

This makes it an interesting alternative to power harrow combinations, while also offering a wider range of usage.

Depth precision to rely on

Rapid is known for its excellent depth keeping.
The result is seen in an even emergence,
maximising the yield potential over the entire field.





Ingenious coulter system

The heart of Rapid is its unique seed coulters working in cooperation with the packer wheels. Rapid has an ingenious depth control system, adjustable from the cab.

The relation between the seed discs and the packer wheel sets the maximum seeding depth, while the very high coulter pressure makes sure this never decreases. Thanks to this, Rapid is able to create an even emergence at all times.



Putting the depth first

Rapid is designed to never let factors such as shifting field conditions or high working speeds affect the seed depth. This is achieved by putting a very high pressure, from 150kg on the seed coulters, while also controlling the depth by connecting two seed coulters to one packer wheel. As a result, Rapid is able to create an even emergence at all times.

The expert of soil types

No matter if the soil is heavy, medium or light, the large OffSet mounted packer wheels will always stay on the field surface and deliver the correct seed depth. This makes Rapid the ideal choice when your soil conditions vary and you need a seed drill to rely on. By easily setting the working depth as well as seed and fertiliser rate from the cab, Rapid allows for a versatile precision farming, adapted according to your local soil conditions.



Follows the ground

By connecting two seed coulters to each packer wheel with a parallel linkage, Rapid is able to follow to the ground contour. This ensures that the seeds has the same conditions for germination across the entire working width.

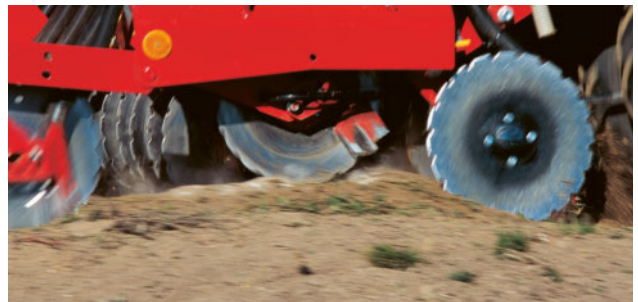

Not easy to disturb

Each seed coulters is fitted to its own rubber suspended disc arm. Because of the heavy-duty design and high coulters pressure, the seed coulters will not release easily. In many cases Rapid presses stones down rather than altering the seed depth. If however encountering a larger stone or obstacle the seed coulters will quickly release and return individually. Thereby the impact on the seeding and reconsolidation result is minimised.

Best start possible for each seed

The high quality Rapid seed coulters are designed to give the seeds the best start possible. This promotes fast germination and healthy crop with high resistance towards weeds, pests and harsh weather.





Great conditions for growth

Each seed disc on a Rapid seed coultter creates a clean seed furrow by aggressively cutting into the firmer bottom of the cultivated seedbed. This creates an environment with several important benefits for the growth of the seed.

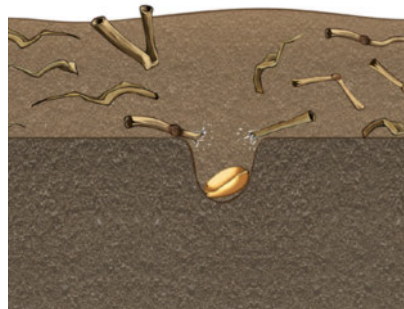
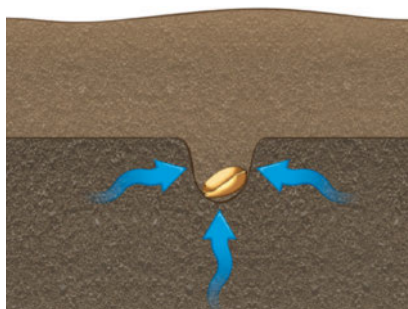

Moisture access for even germination

A key for success lies in the fact that the seed coultter discs have a deeper working depth than the cultivating front tools. Thereby the seed furrow is cut as a narrow slot into a firmer uncultivated layer of soil.

When the seed is placed in the seed furrow, it is able to benefit from the surrounding uncultivated soils' ability to transport moisture. This gives excellent opportunity for the seed to quickly start its growth process, giving it the upper hand on weeds and slugs.

Fine soil creates seed-to-soil contact

The seed discs are mounted on rubber suspended disc arms, positioned in a slight angle to the driving direction. Because of this angle, the aggressive seed discs provide a cultivating action able to turn any leftover clods or aggregates into fine soil.

This ensures that the soil on top of the seed is aerated and delivers optimum seed-to-soil contact which is crucial for taking the next step in the germination process.

Clean seed furrow for undisturbed plant growth

Thanks to its aggressive seed disc, Rapid is always able to create a hygienic, clean seed slot without straw incorporation through hairpinning. This means that the early stages of the plant growth will not be disturbed by crop residues close to the seed.

Since the seed has been cut into the seedbed, the plant is less sensitive to mechanical weed treatment.

125mm row spacing for maximum yield

1

Competitiveness

A narrow row spacing provides the crop with considerably higher competitiveness against weeds. This is especially important as more herbicide resistant weeds are on the increase. Research shows that 125mm row spacing results in 20% less weeds than 150mm.

2

Population distribution

125mm row spacing gives a better population distribution, allowing for a larger spacing between the seeds in the row. The fungi pressure is reduced.

Maximum performance – minimal maintenance

Maintenance free coultter suspension

Each disc arm is fitted with its own rubber suspension. The absence of moving parts, ensures a problem free ownership and long working life.

Swedish steel - Swedish quality

The Rapid seed discs are built from special hardened Swedish steel. This carefully selected raw material delivers a robust construction, excellent performance and extremely long working life in the field.



Less downtime

All bearings are grease free, maximising your time in field.

Heavy-duty seed coultter

The seed coultter has a hardened steel tip and a sideplate of tungsten, providing superior resistance to wear.

3

Canopy closure

Since narrow rows closes faster, the evaporation is reduced at a time when the access to moisture is most crucial.



Reconsolidation after seed placement

Rapid is equipped with large and wide packer wheels, applying heavy reconsolidation, giving it the ability to always close the seed slot. The weight is especially needed when drilling deep, working on heavier soils or when practicing direct drilling.



Same conditions for each seed

By applying heavy reconsolidation after placing the seed, the Rapid packer acts as a roller with high precision. By putting pressure on the right spot, this ensures great seed-to-soil contact for each seed, saving additional roller passes, while also pressing down stones.

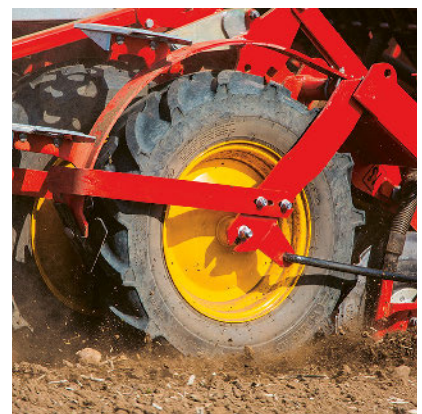

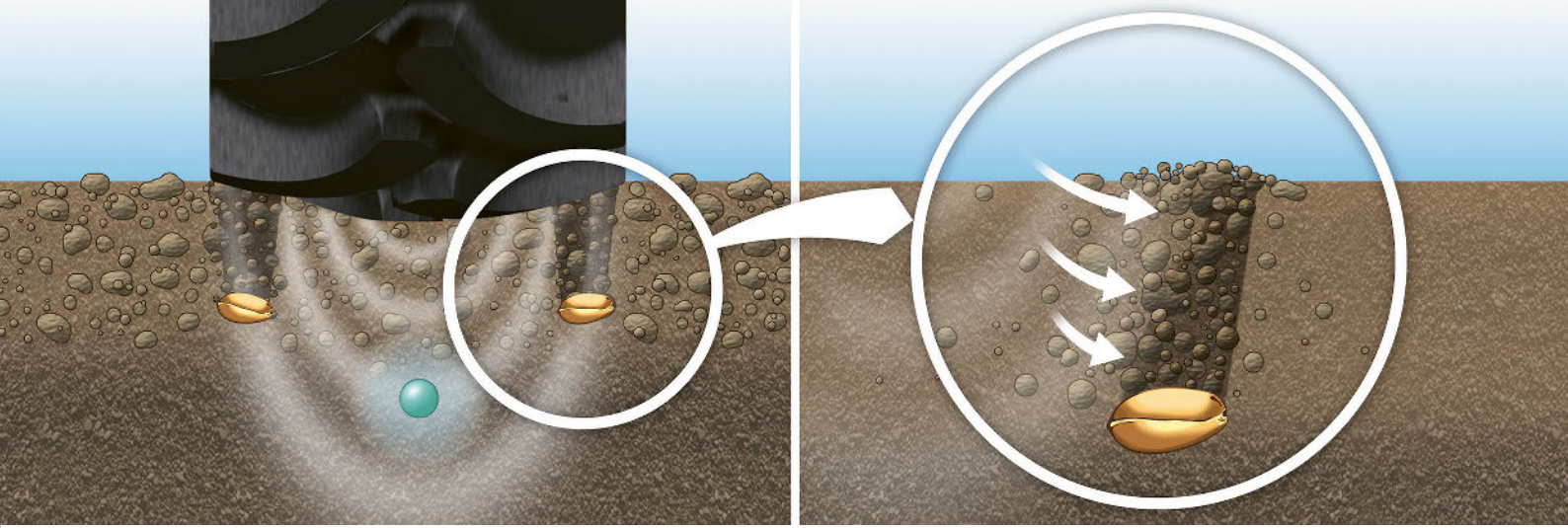

One wheel over two seed rows

The large packer wheels effectively closes the seed and fertiliser slots, ensuring seed-to-soil contact.

The sideways pressure over the seed prevents capping, while the straight pressure over the deeply placed fertiliser ensures faster dissolving of the nutrient.

OffSet provide benefits

OffSet means that every second packer wheel is displaced 190mm backwards on a separate axle. This solution both improves the agronomy and farm economy as well as increases the range of usage in moist conditions.



Lower draught requirement

According to studies, OffSet minimises bulldozing and lowers the draught requirement by 25%.

Depth precision

OffSet provides a calm ride, leading to lower vibrations. This results in higher depth precision.

Great carrying capacity

Having two separated wheel axles increases the contact surface to the soil, providing great carrying capacity.

Combi drilling secures success

Rapid is available with and without fertiliser metering. Nutrient placement during drilling provide a fast and reliable fertilisation effect. Since the fertiliser is placed in moist soil there is less dependence on rain, while placement also gives high yields and better nutrient use efficiency. This reduces input costs, while maintaining yield.

Fertiliser at the right spot

The fertiliser is placed between every second seed row at a row spacing of 250mm. This means that the fertiliser ends up 6.25cm from each row of seed. This results in the fertiliser being easily accessible to the seed, giving the crop a heads start over any competing weed.

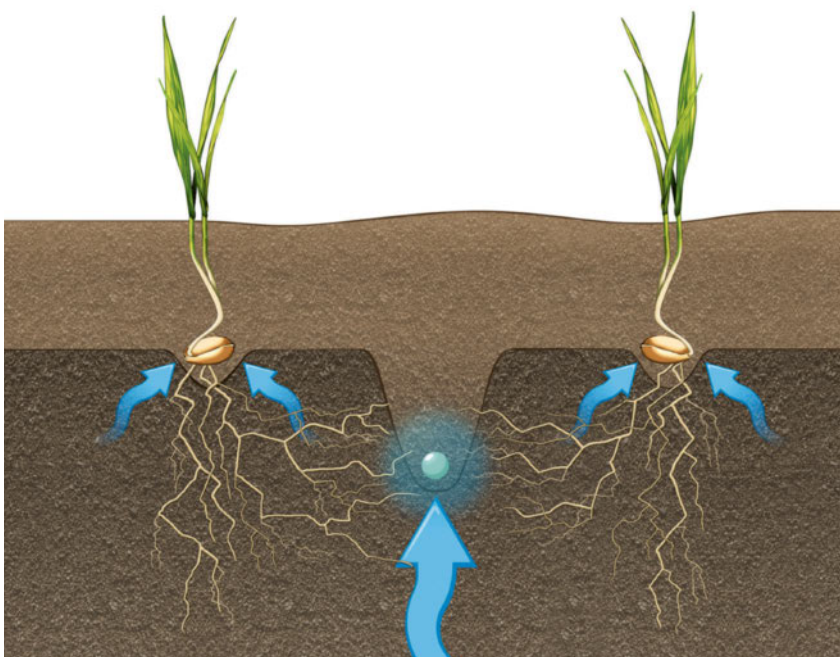

With the Rapid method the fertiliser is placed at 250mm row spacing between two rows of seed, allowing full moisture access.

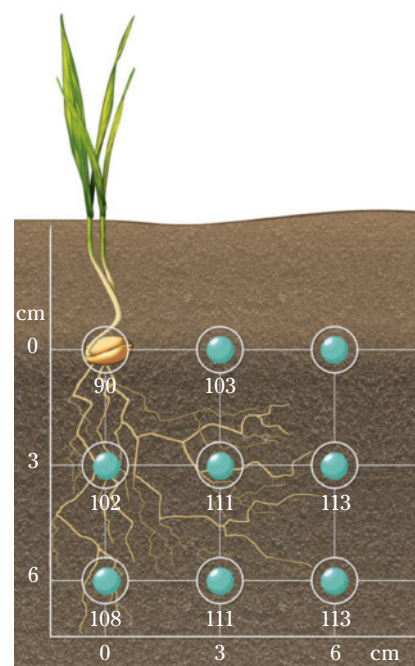

Studies show yield increases if fertiliser is placed deeper and to the side of the seed (spring drilling). Index 100 = broadcasting

Efficiency in all conditions

The fertiliser is placed with the same disc couler types as the seeds. By cutting a clean slot, the fertiliser is separated from any crop residues. This makes the nitrogen fully available for the plant, lowering the risk of being used for straw decomposition.

High capacity fertiliser output

The fertiliser is metered out hydraulically with a very high capacity. This means that the fertiliser metering will never limit the working speed.

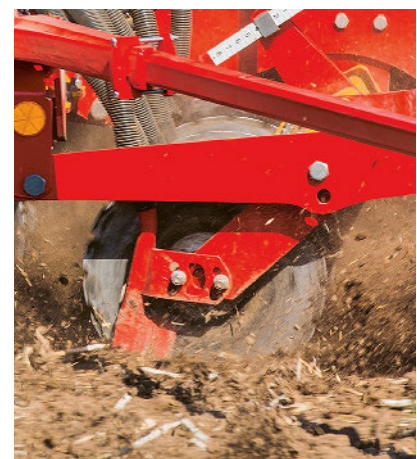



BioDrill - Multiple products in one pass

By equipping Rapid with the mountable small seeder BioDrill, a small seeded crop such as cover crops or ley, can be drilled together with the main crop. The spreader plates distribute the seed evenly in front of the packer

wheels, securing a good seed-to-soil contact. BioDrill provides excellent conditions for a small-seeded crop, reducing seed costs and retaining soil moisture at the same time.



Rapid 300-400C/S can be fitted with BioDrill 180-250. It has a gravity fed metering system with few moving parts, resulting in minimal maintenance and long working life.



Rapid A 400-800S and Rapid A 600-800C can be fitted with BioDrill 360. The pneumatic BioDrill 360 is equipped with electric Fenix II metering system, allowing for uniform drilling of small-seeded crops with precision down to a seed rate of 1kg per hectare.



SeedEye

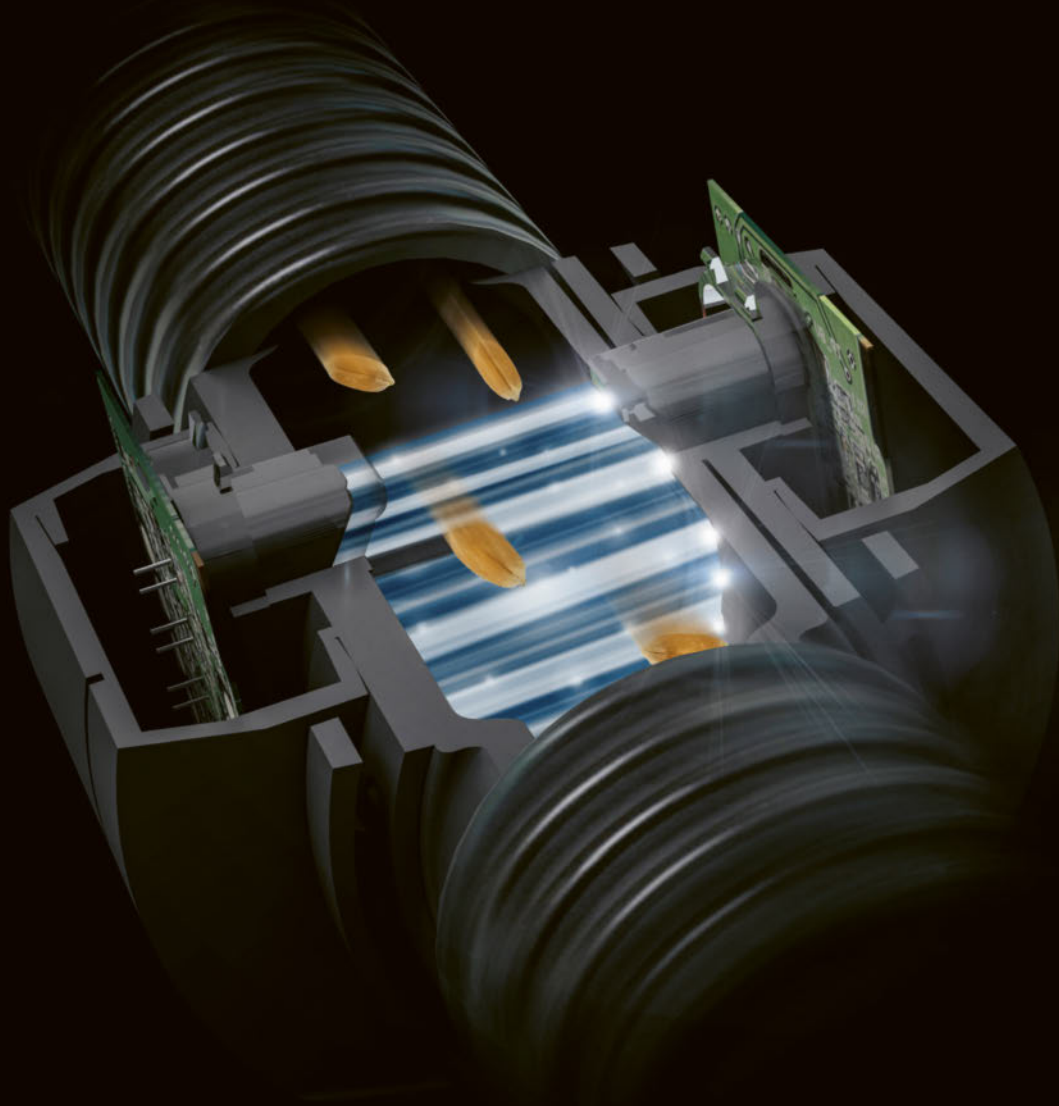

Precision and performance in focus

The unique Väderstad SeedEye sensors provide an insight with precision down to each individual square metre within the field. With access to exact data, you are able to make informed decisions for increased efficiency and maximised results in the crop production.

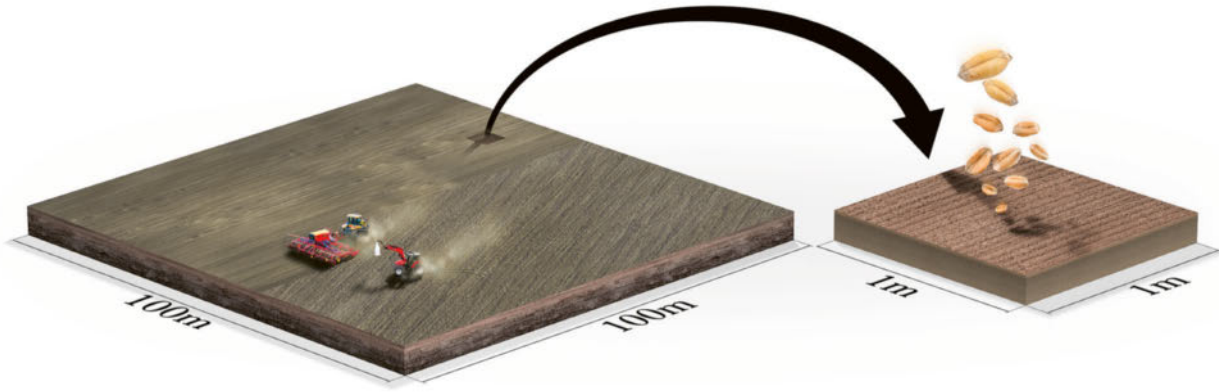

Seeds per square metre instead of kilo per hectare

Using Väderstad SeedEye, the desired seed rate is set in terms of number of seeds per square metre. In the field, sensors accurately records the number of seeds passing through each individual seed tube. By combining this information with driving speed data from the seed drill ground radar, the output is automatically adjusted to maintain the selected seed rate.

No calibration required. Maximised time in the field.

SeedEye automatically adjusts the seed rate on the move so there is no need for calibration. This increases the ease-of-use as well as maximising field efficiency. In the cab, you have full control of the seeding operation via the iPad based control system Väderstad E-Control.



SeedEye ensures great results

Increasing access to information is the cornerstone of smarter farming. Since SeedEye registers each individual seed and fertiliser passing through the tubes, the seeding is visualised in real time. If a deviation should occur, SeedEye gives an immediate warning so that any impact on the drilling can be quickly remedied.

Take full control of the seeding

Väderstad SeedEye puts the control in your hands giving you the opportunity to fully optimise the result on the field.

By measuring seeds per square metre, instead of weight per hectare, the seeding result is no longer affected by variations in different seed bags or seed types. This increases precision and maximises seeding performance.

Working with ISOBUS Task Controller, a variable seed rate and sectional shut off is also possible.

Front tools

CrossBoard Heavy

CrossBoard Heavy consists of hardened CrossBoard tines that can be equipped with different tools depending on conditions. CrossBoard Heavy is suitable for cultivated soils and to level the field and break clods.



System Agrilla

System Agrilla consists of tines in different combinations with CrossBoard. The vibrating tines loosen the soil and break the capillary. The fine soil is sorted into the seedbed and weeds are brought to the surface. The CrossBoard additionally levels the field and break clods. System Agrilla is a light weight alternative, reducing the draught force requirement of the machine.



System Disc

System Disc is a versatile disc front tool, consisting of two rows of intensively cultivating and cutting discs. Depending on the soil conditions, System Disc can be complemented with CrossBoard Light or Heavy, to level the field and break up clods.



System Disc Aggressive

System Disc Aggressive is a powerful and versatile disc front tool. Its conical discs add cultivation capacity, allowing full cut-out at shallow working depth. This enables incorporation of weeds together with drilling. System Disc Aggressive can be complemented with CrossBoard Light or Heavy, to level the field and break up clods.





Rapid 300-400C/S

The three or four metre wide box seed drill Rapid 300-400, is available either as seed-only or combi version. You benefit from reliable results and a modern design, allowing easy access throughout the machine.



Thanks to its versatility the machine is able to handle multiple crops, grass leys and cover crops, as well as micro granulates or slug pellets. Equipped with the mountable small seeder BioDrill, an additional product is added.

Hydraulic metering

Rapid 300-400C/S is equipped with hydraulic metering, powered from the tractor. To match the pre-set seed rate, the metering system constantly communicates with a ground radar, measuring the forward speed.

This very reliable system secures high precision metering, resistant to vibrations and irregularities on the field. Further, the system is very easy to set and calibrate.

Large hopper - high capacity

To reduce filling downtime, the box seed drills Rapid 300-400C/S have high capacity hoppers. The hopper is designed with a large opening, allowing for fast and easy filling. The combi models are equipped with an adjustable wall that separates the seed and fertiliser in the hopper.

Depth setting from the cab

To be able to instantly adapt to varying soil types or differing conditions in the field, Rapid 300-400C/S can be equipped with the automatic seed depth control AutoPilot or the seed depth measurement AutoCheck.

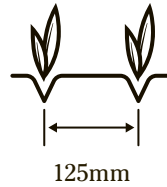
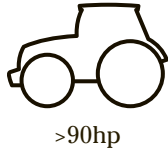
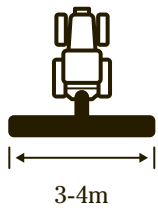

Versatility is key



Front tools



CrossBoard Heavy



System Agrilla
CrossBoard Heavy



System Disc Aggressive



System Disc
CrossBoard Light



System Disc
CrossBoard Heavy



System Disc Aggressive
CrossBoard Heavy



The modern design is focused on simplicity and ease of access throughout the machine.



Rapid 300-400C/S has a high capacity hopper. On the combi models, the relation between seed and fertiliser is easily altered.

Rapid A 400-800S

The pneumatic seed drill Rapid A 400-800S is a powerful drill ready for future farming. Rapid A 400-800S is designed with the driver in focus, while never compromising on the important seeding precision and crop quality.



The three seed drills in the product family are seed-only versions equipped with a high precision metering system.

Exact seed metering

At the base of the seed hopper, the seed enters the hydraulic metering system and is distributed pneumatically to the distribution heads.

The metering system Fenix can handle seed rates from 1.5kg/ha up to 500kg/ha without any parts having to be changed. Thanks to the hydraulic drive, high seed rates can be metered without lowering the driving speed. The integrated fan runs at low speed, resulting in low fuel consumption and quiet operation. Its high location reduces the amount of dust and crop residues that get in, increasing drilling accuracy.

Depth setting from the cab

To be able to instantly adapt to varying soil types or differing conditions in the field, Rapid A 400-800S can be equipped with the unique depth control system Interactive Depth Control (IDC). The system enables fine-tuning of the seeding depth with 1mm accuracy on the move.

Combined with the ability to alter the seed rate, the driver is constantly in full control of the seeding operation.

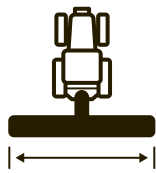

4-8m



2900-3100 litre

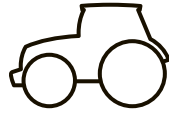

>130hp

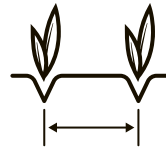

125mm

Ready for future farming



Front tools



CrossBoard Heavy



System Agrilla
CrossBoard Light



System Disc



System Disc
CrossBoard Light



System Disc Aggressive
CrossBoard Light



Rapid A 400–800S has a centralised platform with access from both sides, saving time for the operator.

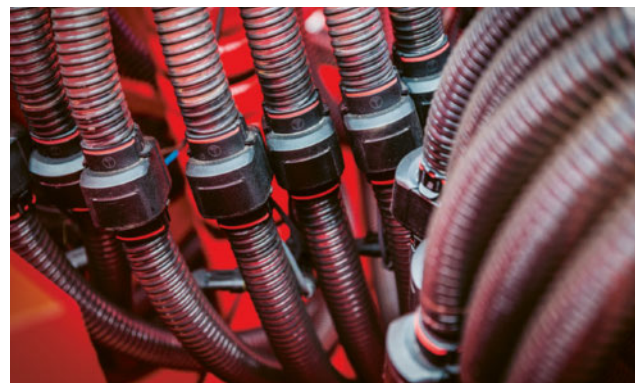

With SeedEye you can easily set the number of seeds per square metre, without the need for calibration. SeedEye ensures excellent seeding results with full control.

Rapid A 600-800C/J

The seed drills in the product family Rapid A 600-800C/J have pneumatic seed transport with a very high drilling capacity. Rapid A 600-800C/J combine an impressive capacity with easy manoeuvring and great results.



The machine is available either as the combi-version Rapid A 600-800C, or as the seed-only version Rapid A 600-800J. All models have an extensive hopper capacity of 6000 litres.

Designed for high output rates

The high capacity hydraulically driven metering system Fenix is able to handle all seed sizes in application rates from 1.5kg/ha up to 500kg/ha, without having to change any parts.

This means that the metering system will never be a limiting factor for high rates and high speed drilling on the field.

Adjust seeding depth on the move

To be able to instantly adapt to varying soil structure or differing conditions in the field, Rapid A 600-800C/J can be equipped with the unique depth control system Interactive Depth Control (IDC). The system enables fine-tuning of the seeding depth with 1mm accuracy on the move.

Combined with the ability to alter the seed rate, the driver is constantly in full control of the seeding operation.

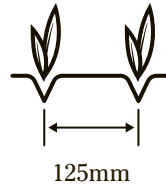
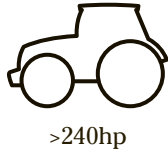
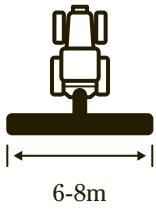

Extreme capacity



Front tools



CrossBoard Heavy



System Agrilla
CrossBoard Heavy



System Disc



System Disc
CrossBoard Heavy



The turning radius is impressively small despite the size of the machine.

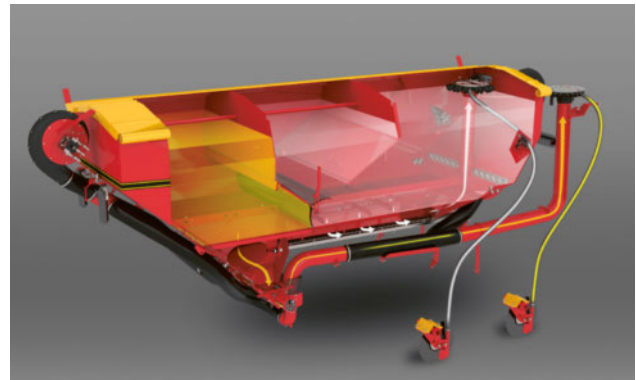

The big hopper has an adjustable dividing wall that separates its two sections. An hydraulic auger meters the fertiliser.

Väderstad E-Control – New generation control system

The iPad-based control system Väderstad E-Control wirelessly connects to the Väderstad machine enabling full access to its functions and data. You benefit from user-friendly remote setup and calibration, as well as real-time monitoring and control.



The portable office

Väderstad E-Control is a fully portable control system ready to be used when and where it is required. When calibrating the Väderstad machine, you can take the portable iPad out of the tractor and control the calibration from outside.

When your day is over you can take the iPad to the office and start planning the next days work.

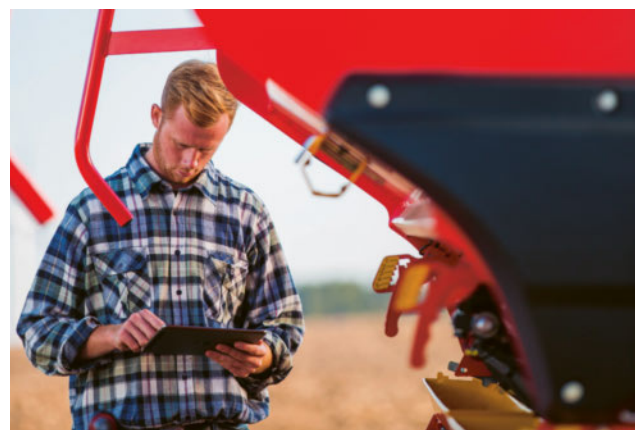

State of the art graphics

The high-resolution iPad-display presents all the information clearly.
The outstanding graphics make every function easier to utilise.

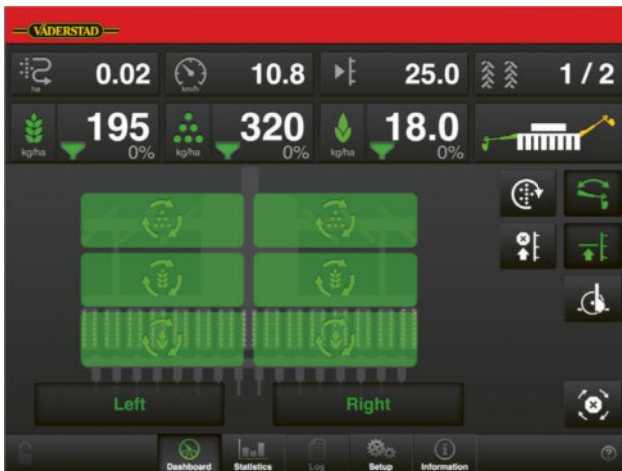

Since Väderstad E-Control is used for many planters and seed drills in the Väderstad range, the same iPad can be used for multiple machines on the farm.

Always up to date

At Väderstad, we find it very important to support and service all our customers to the fullest. Therefore, all E-Control software updates are easy to download free of charge. With E-Control, you are always sure to benefit from the latest technology and the newest innovative solutions from Väderstad.

Combined control with ISOBUS Task Controller

Using Väderstad E-Control together with an ISOBUS terminal allows for automatic GPS section control and variable seed rate. A list of terminals compatible with ISOBUS Task Controller can be found on our web page vaderstad.com by searching for ISOBUS.

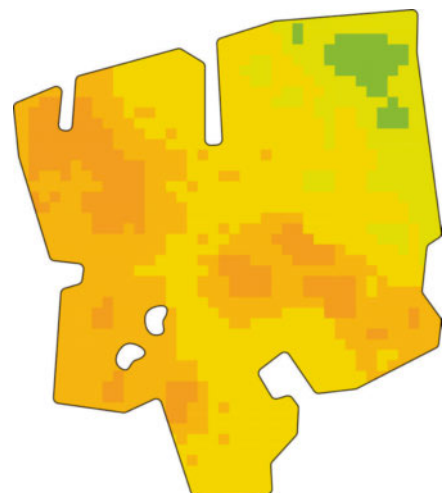

Accessories



Control system

Rapid can be operated either with E-Control, ISOBUS-terminal or ControlStation.



Drawbar and towing eye

The following options are available: towing eye 40/50mm, Ball coupling 80mm, Ball towing eye 42/51/71mm.

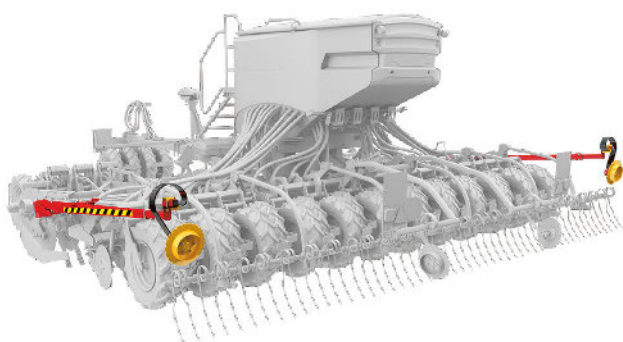

Markers arms

Marker arms with easy adjustment for different soil conditions.

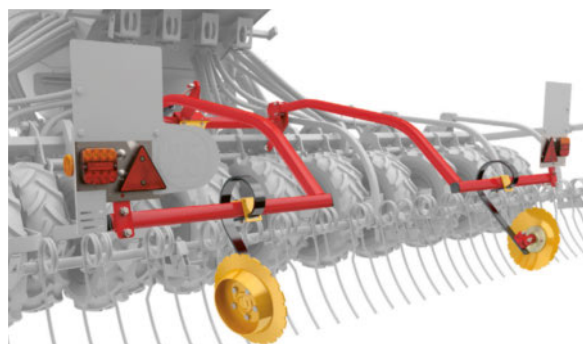

Pre emergence marker

The pre emergence markers consists of discs marking the position of tramlines, without disturbing the seeds.



Micro granulate kit

Rapid 300-400C/S with BioDrill can be equipped with a micro granulate kit, enabling for example, placement of a starter phosphorus together with the seeds.



Hydraulic support leg

The hydraulic support leg can be fitted to Rapid 300-400C/S and Rapid A 400-800S to simplify connection.



Pivot packer

Rapid 300-400C/S and Rapid A 400-800S can be fitted with 4 or 6 pivoting packer wheels.



Work light

Provides good lighting for long working days with Rapid A 400-800S.

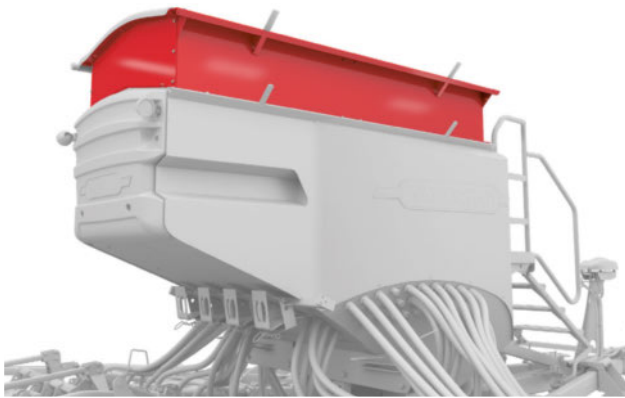

Hopper extension

The hopper extension increases the hopper volume with 750 litres for Rapid A 400-800S.

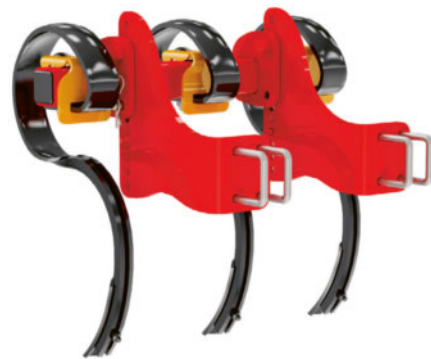

Track eradicators

Loosens the soil in the tractor wheel tracks. Fits Rapid A 400-800S.



Slug pellet spreader plates

Enables application of slug pellet together with the drilling operation. Fits Rapid A 400-800S and Rapid A 600-800C/J, equipped with BioDrill 360.



Wing packer

Consolidates the soil for a perfect emergence in lighter soil conditions. Fits Rapid A 400-800S and Rapid A 600-800C/J.

	RD 300C	RD 300S	RD 400C	RD 400S
Working width (m)	3.0	3.0	4.0	4.0
Transport width (m)	3.0	3.0	4.05	4.05
Transport height (m)	2.7	2.7	3.2	3.2
*Basic weight (kg)	2900	2400	3800	3400
Hopper (l)	3150	3000	4350	4100
**Coulter pressure min/max (kg)	82/245	70/210	90/230	75/215
Number of seed coulters	24	24	32	32
Number of fertiliser coulters	12	-	16	-
Row spacing seed (mm)	125	125	125	125
Row spacing fertiliser (mm)	250	-	250	-
Wheel dimension	190/95-15	190/95-15	190/95-15	190/95-15
***Hydraulic requirement	2-4 DA + FR	2-4 DA + FR	2-4 DA + FR	2-4 DA + FR
Oil flow requirement (l/min)	70	70	70	70
Draught requirement (hp)	100-175	90-165	130-240	120-220

*With CrossBoard Heavy

**Fertiliser coulters up, only seed coulters working, empty hopper

***4 DA and 1 FR with AutoPilot

	RDA 400S	RDA 600S	RDA 800S
Working width (m)	4.0	6.0	8.0
Transport width (m)	3.0	3.0	3.0
Transport height (m)	3.1	3.1	4.0
Basic weight (kg)	5200	6000	7700
Hopper (l)	2900	3100	3100
Coulter pressure min/max (kg)	117/255	110/205	88/175
Number of seed coulters	32	48	64
Row spacing seed (mm)	125	125	125
Wheel dimension	190/95-15	190/95-15	190/95-15
*Hydraulic requirement	3-4 DA+3/4" FR	3-4 DA+3/4" FR	3-4 DA+3/4" FR
Oil flow requirement (l/min)	90	90	90
Draught requirement (hp)	130-210	180-350	240-400

* With CrossBoard Heavy or System Disc you need 3 DA + 3/4" FR. With System Agrilla CrossBoard Light, System Disc CrossBoard Light or System Disc Aggressive CrossBoard Light you need 4 DA + 3/4" FR.

DA= Double action

FR= Free return

	RDA 600C	RDA 600J	RDA 800C	RDA 800J
Working width (m)	6.0	6.0	8.0	8.0
Transport width (m)	3.0	3.0	3.0	3.0
Transport height (m)	3.5	3.5	4.0	4.0
Basic weight (kg)	7300	6950	8700	7600
Hopper (l)	6000	6000	6000	6000
Coulter pressure min/max (kg)	95/195	90/190	85/165	75/155
Number of seed coulters	48	48	64	64
Number of fertiliser coulters	24	-	32	-
Row spacing seed (mm)	125	125	125	125
Row spacing fertiliser (mm)	250	-	250	-
Wheel dimension (front)	700/50-26.5	700/50-26.5	700/50-26.5	700/50-26.5
Wheel dimension (rear)	190/95-15	190/95-15	190/95-15	190/95-15
*Hydraulic requirement	3 DA+3/4" FR	3 DA+3/4" FR	3 DA+3/4" FR	3 DA+ 3/4" FR
Oil flow requirement (l/min)	125	100	125	100
Draught requirement from (hp)	240-400	190-400	260-450	250-450

***Hydraulic requirement with PTO pump**

If the hydraulic capacity of the tractor's outer hydraulics is lower than 160 l/min a PTO pump is used.

Machine equipped with the front tool CrossBoard Heavy = 3 DA + 3/4" FR

Machine equipped with the front tool System Agrilla CrossBoard Heavy or System Disc CrossBoard Heavy = 4 DA + 3/4" FR

DA= Double action

FR= Free return

***Hydraulic requirement without PTO pump**

If the hydraulic capacity of the tractor's outer hydraulics is higher than 160 l/min there is no need for a PTO Pump

Machine equipped with the front tool CrossBoard Heavy = 4 DA + 3/4" FR

Machine equipped with the front tool System Agrilla CrossBoard Heavy or System Disc CrossBoard Heavy = 5 DA + 3/4" FR

Reliable and durable farm machinery



*2-year warranty on
Väderstad seed drills,
planters and tillage
equipment.*



*Lifetime manufacturing
warranty on all genuine
Väderstad discs.*



Where farming starts